

Diagramas de conexión Alimentadora Icubica

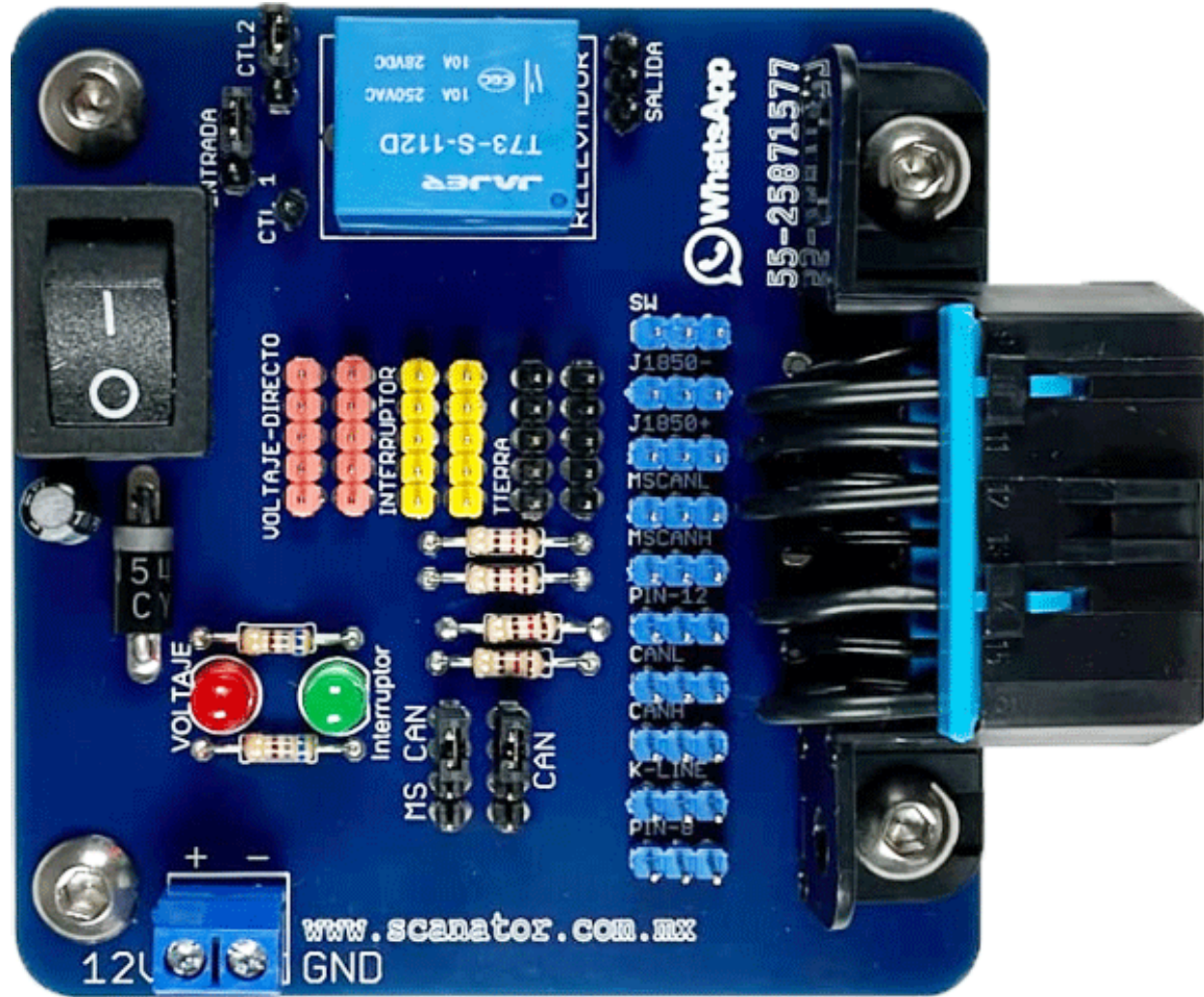

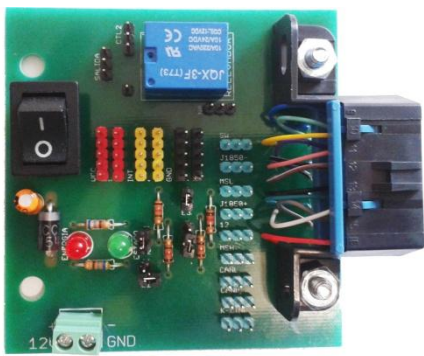

V2.0

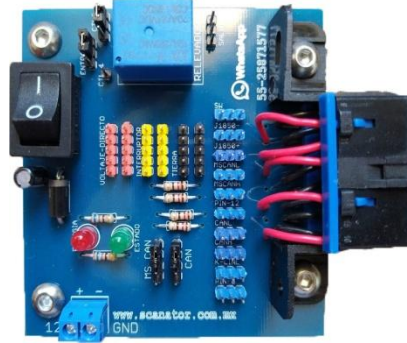

V3.0

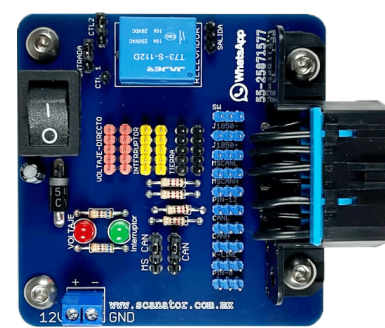

V4.0

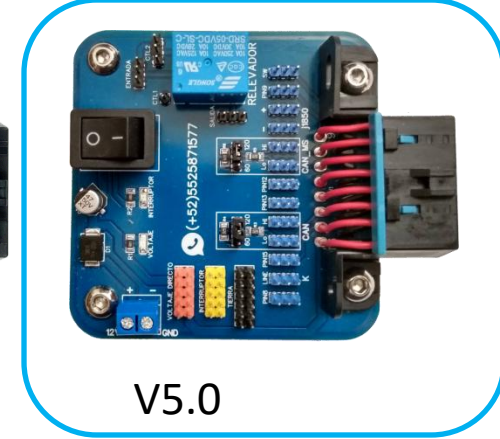

V5.0

Conexión de relevador V5.0

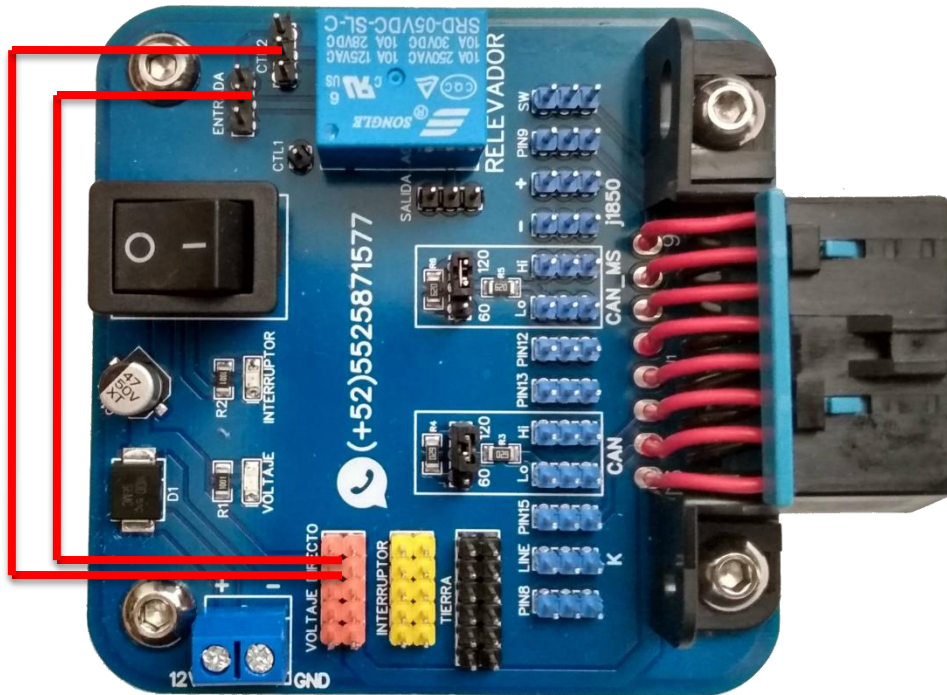

Nota: Para la utilización del relevador en la nueva versión V5.0 usar un cable de los pines de voltaje al pin central de entrada, y usar otro cable de los pines de voltaje al pin central de CTL2



Identificador de la versión

Menú 1/2

Chevrolet / GM / Opel / Daewoo

ECU Chevy	Delphi DCM3.7AP	TCM 6T35	TCM 6L50	X18NE(1) Meriva
Acdelco E38	Acdelco e78	TCM 6T40	TCM 6L80	T18NE(1) Corsa
Acdelco E37	Acdelco e39	TCM 6T45	TCM 6L90	T18NE(1) Meriva
Acdelco E84	Acdelco e39a	TCM 6T50	Z14XE Corsa	T18NE Tornado
Acdelco E98	Acdelco e92	TCM 6T70	ECU Chevy INMO	Z18XE Astra
Acdelco e83	Acdelco e80	TCM 6T75	C18NE(1) Corsa	Z18XE Zafira
Acdelco e82	Acdelco e67	TCM 6T80	C18NE(1) Meriva	Simtec 71.5 Astra H
Acdelco e87	TCM 6T30	TCM 6L45	X18NE(1) Corsa	Simtec 71.1 Meriva

Simtec 71.1 Astra	Captiva Sport 2008	Cavalier 2005 2.2	GM P10	Bosch E86
Simtec 71.6 Astra H	Equinox 3.4	Optra y AVEO	GM P12	Bosch EDC15C13
X18XE Astra	Tornado 1.8	Uplander 2006 3.5	TCM GM T42	Bosch EDC17C59
X24SE Astra	Sonic 1.6	Trail Blazer 2006 4.2	TCM Allison 5	Bosch TC1767
Z22SE Astra	Malibu 2009	Spark 2010	TCM Allison 6	Optra y AVEO INMO
Z22SE Zafira	Captiva Sport	GM e35	Bosch AS4	Malibu LS 2005
Cobalt	Cobalt 2008	GM e 40	AS41 PSA	Trail Blazer 2003
Cruze 1.8	Silverado 2008	GM P01 / P59	Bosch DCU17PC42	

Selecciona el diagrama deseado dando click sobre el (o puedes desplazarte manualmente)
 Para regresar al Menú en el diagrama busca la liga [Regresar al Menú](#) y dale click

Menú 2/2

Chrysler / Dodge / Jeep / Hyundai

SBECIII 80 pines	Bosch DCU17PC43
GPEC 2	Bosch EDC15C2
Stratus 2006 2.4	Bosch EDC15C5
Atos 2002-2010	Bosch EDC17C57
ECU RAM 700	Caravan 1996
IAW 5SF3	
IAW 5SF8	
IAW 5SF9	

Ford / Land Rober / Mazda

TCM DPS6	Green OAK 2368k
Focus 2004 2.0	Copperhead / ESY Gen 1
Ranger 2.2	Continental Tricore Gen 2
TCM NC 6R80	Bosch Tricore Ecoboost
Focus 2.0 2012-2016	Bosch EDC17C66
EEC V	Bosch TC1793
OAK	Bosch EDC17C70
Black OAK 1472k	Bosch EDC17CP11
TCM Mazda 3 Y 5	Ford Fiesta 2012

Honda / Kia

Civic cupe 1.8
Bosch EDC15C2
Bosch EDC17C57
Bosch EDC17C58
Bosch TC1793

VW / Audi / Seat / Mercedes

Beetle 80 Pines	Bosch EDC15V	Bosch TC1793
Jetta clásico 80 Pines	Bosch EDC15VM+	Bosch EDC17C74 1
Bosch EDC15C4	Bosch EDC15P+	Bosch TC1793 1
Bosch DCU17PC42	Bosch EDC15P	Bosch EDC17C74 2
Bosch EDC15C5	Bosch EDC15V	Bosch TC1793 2
Bosch EDC15C6	Bosch EDC15VM+	Bosch EDC17CP04
Bosch EDC15P+	Bosch EDC17C54	Bosch TC1796
Bosch EDC15P	Bosch EDC17C66	Audi A3 2da Gen

Nissan / Renault / Peugeot

Altima 2007 2.5
Platina ECU 90 pines
Scenic ECU 90 pines
Bosch DCU17PC42
Bosch EDC15
Bosch EDC15C3
Bosch EDC17C84
Bosch TC1782

Toyota / otros

Bosch EDC17CP07
Bosch TC1766

Selecciona el diagrama deseado dando click sobre el (o puedes desplazarte manualmente)
 Para regresar al Menú en el diagrama busca la liga [Regresar al Menú](#) y dale click

Acdelco E38

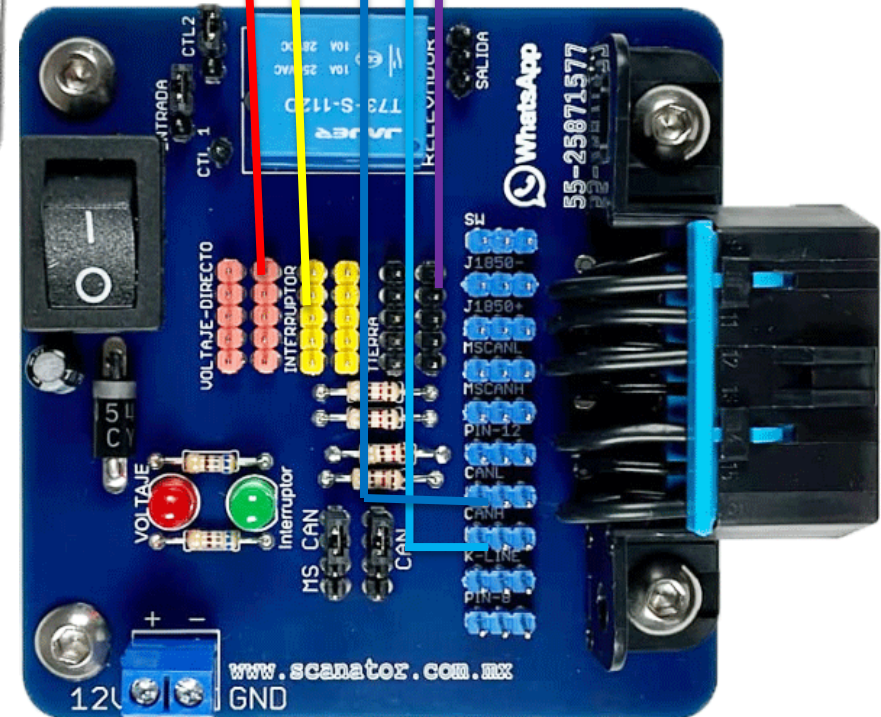
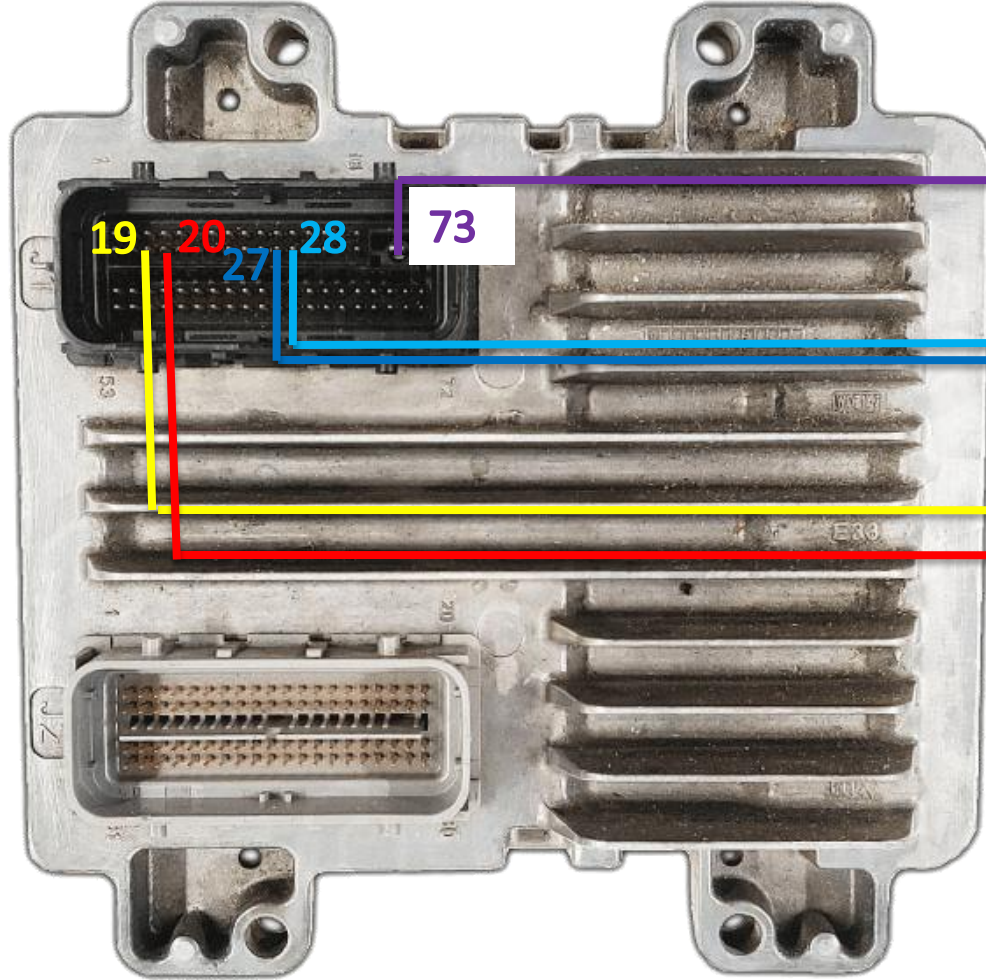

[Regresar al menú](#)

www.scanator.com.mx/alimentadora

Accelco E37

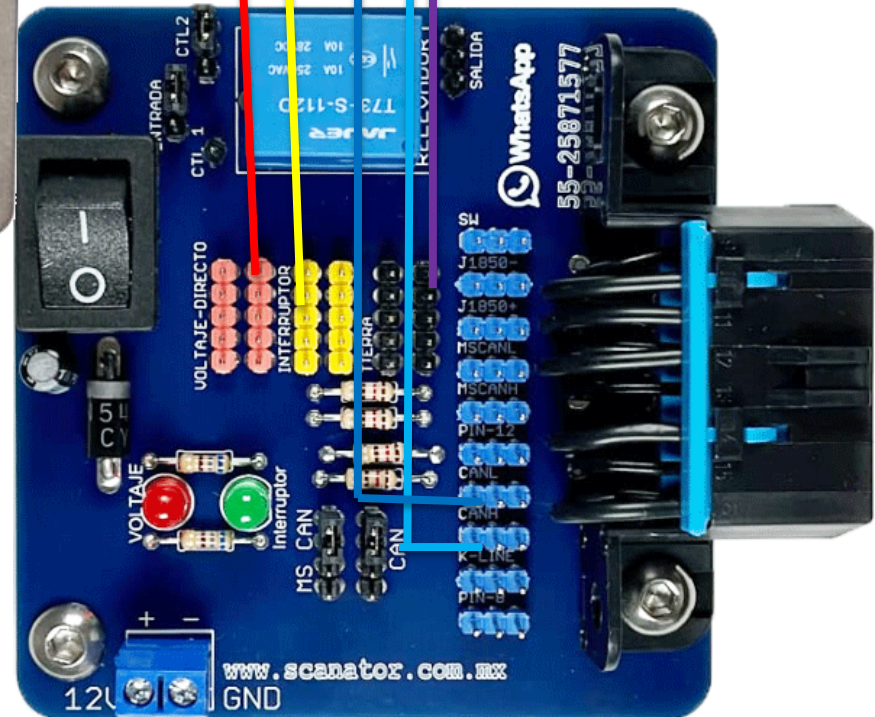
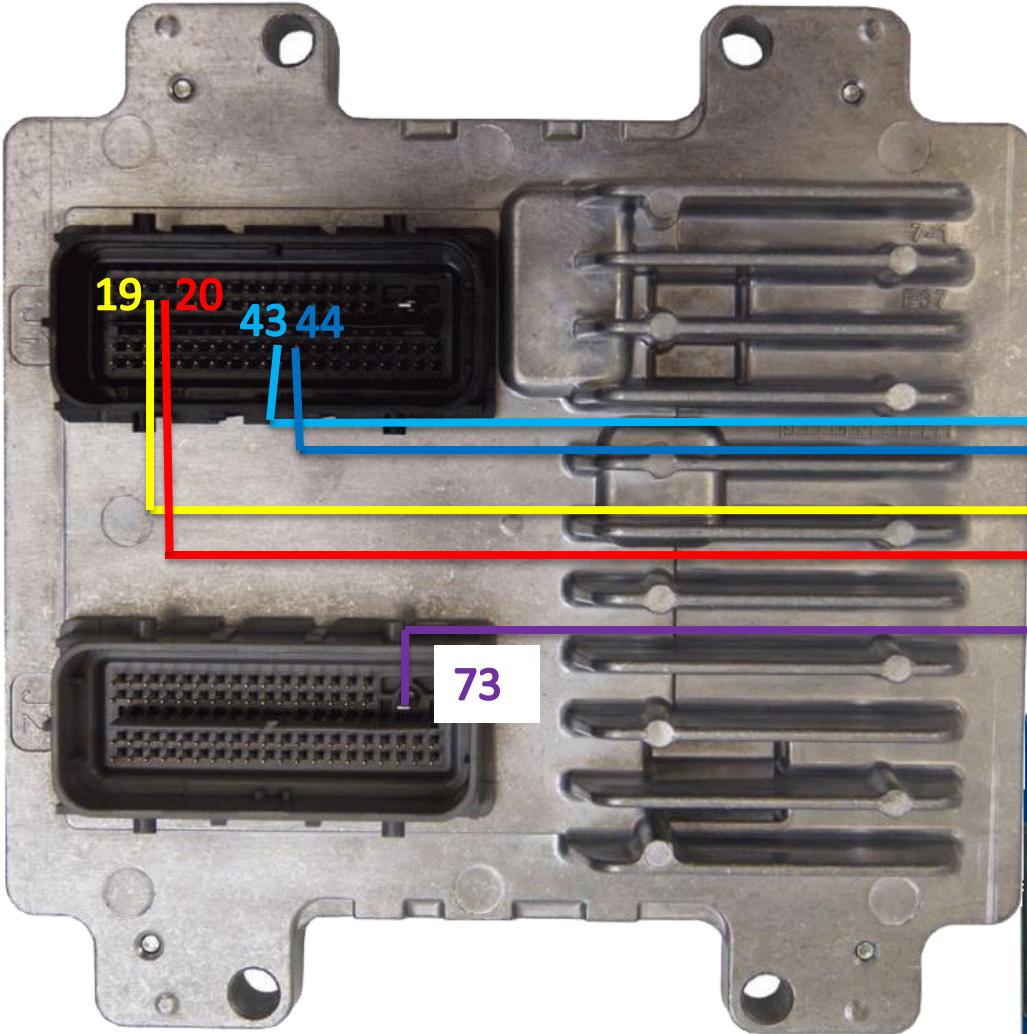

[Regresar al menú](#)

www.scanator.com.mx/alimentadora

Acdelco Bosch
E84
(para uso en SPS)

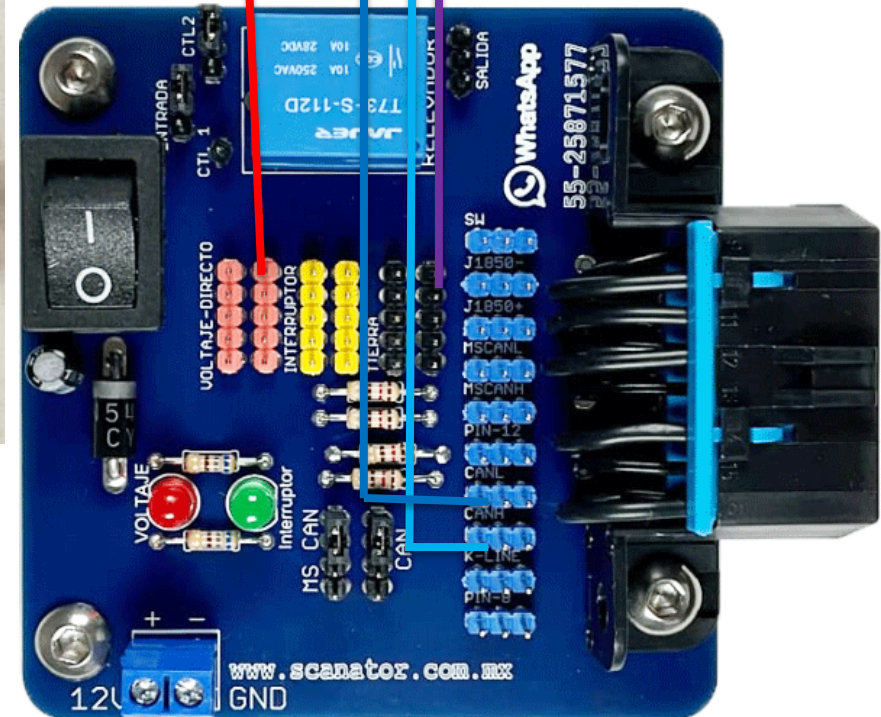
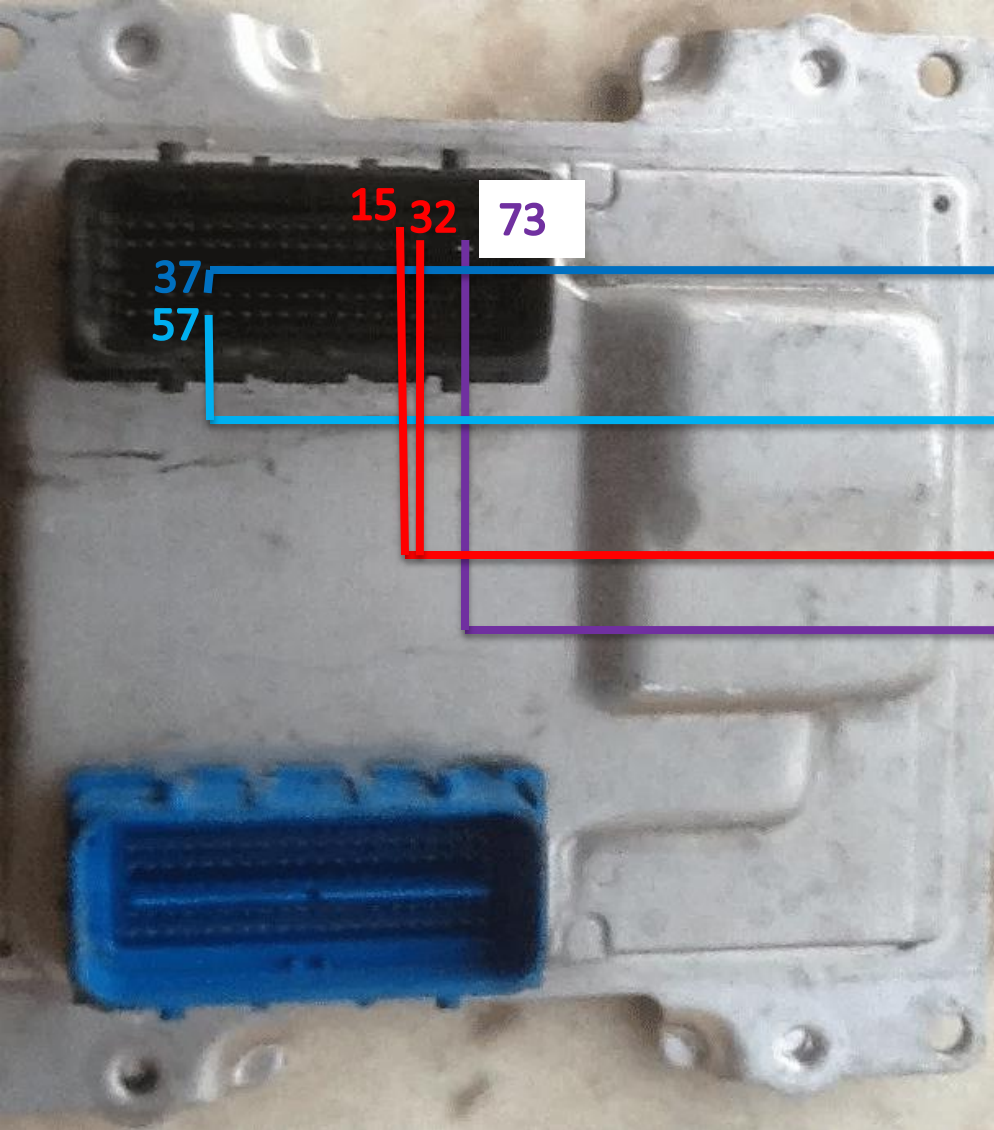

[Regresar al menú](#)

www.scanator.com.mx/alimentadora

Acdelco Bosch E84
(para uso en
pruebas de
alimentaciones)

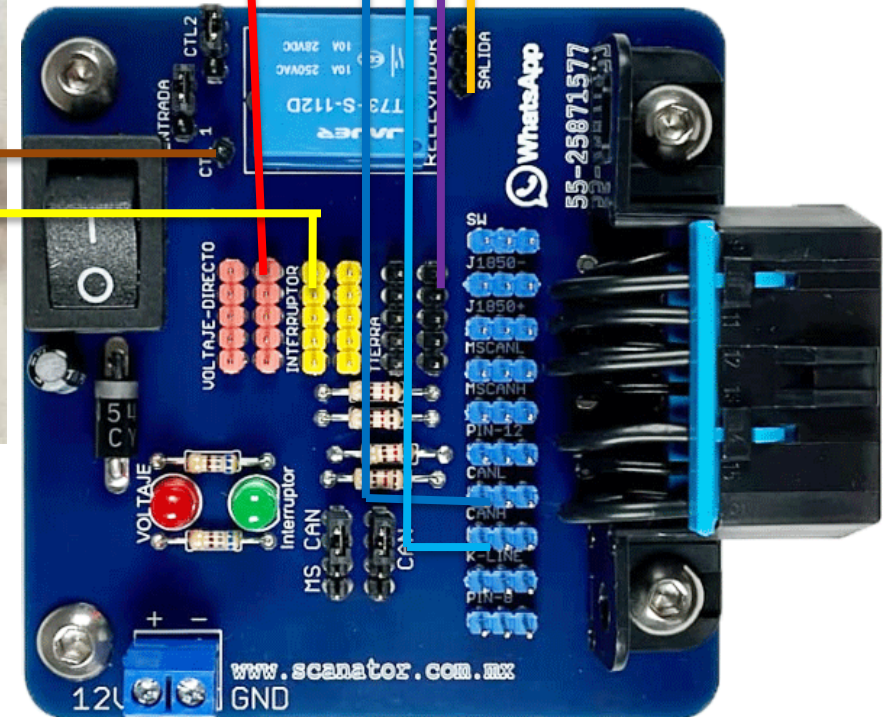
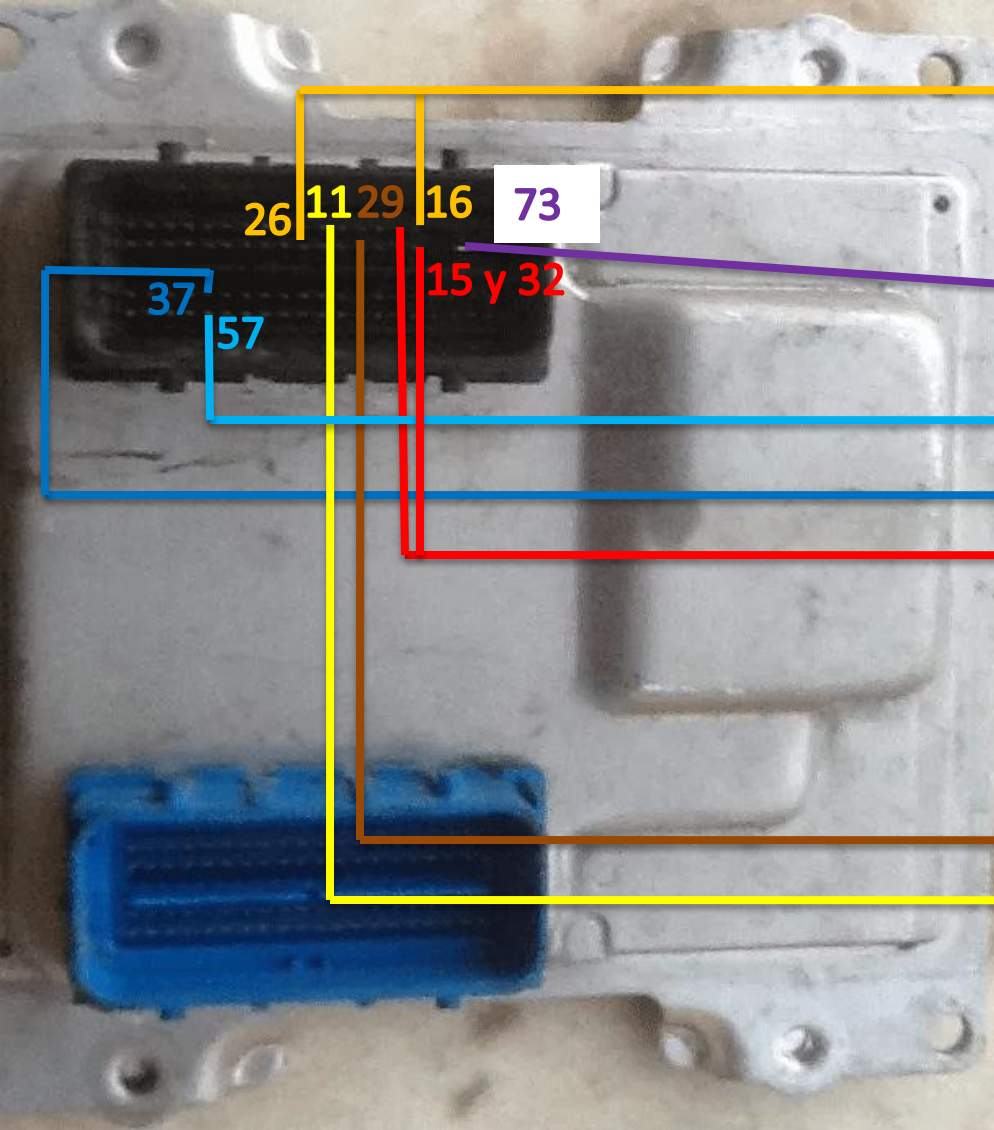

[Regresar al menú](#)

www.scanator.com.mx/alimentadora

Acdelco E98

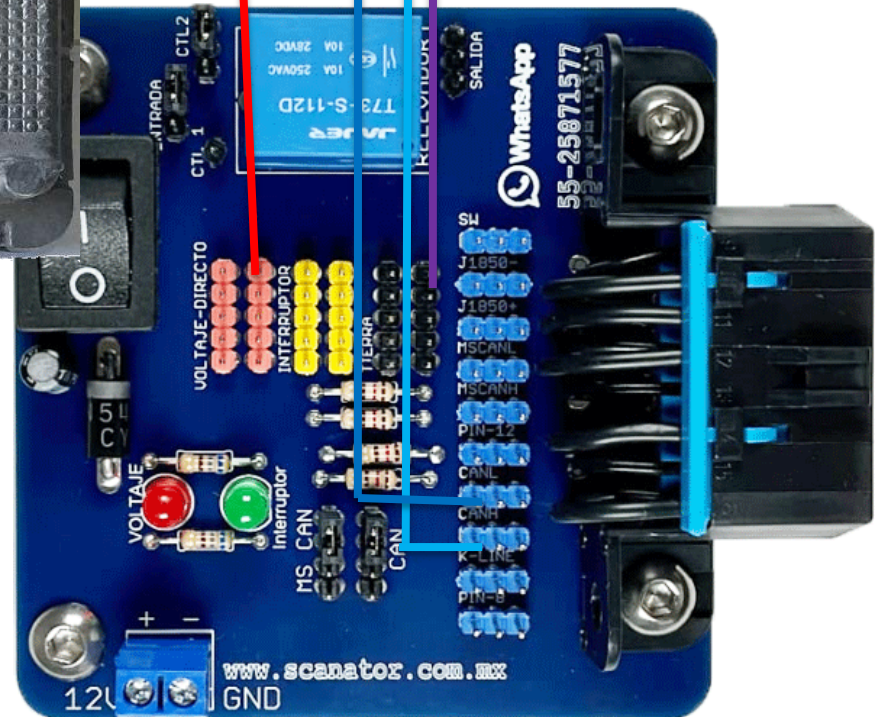
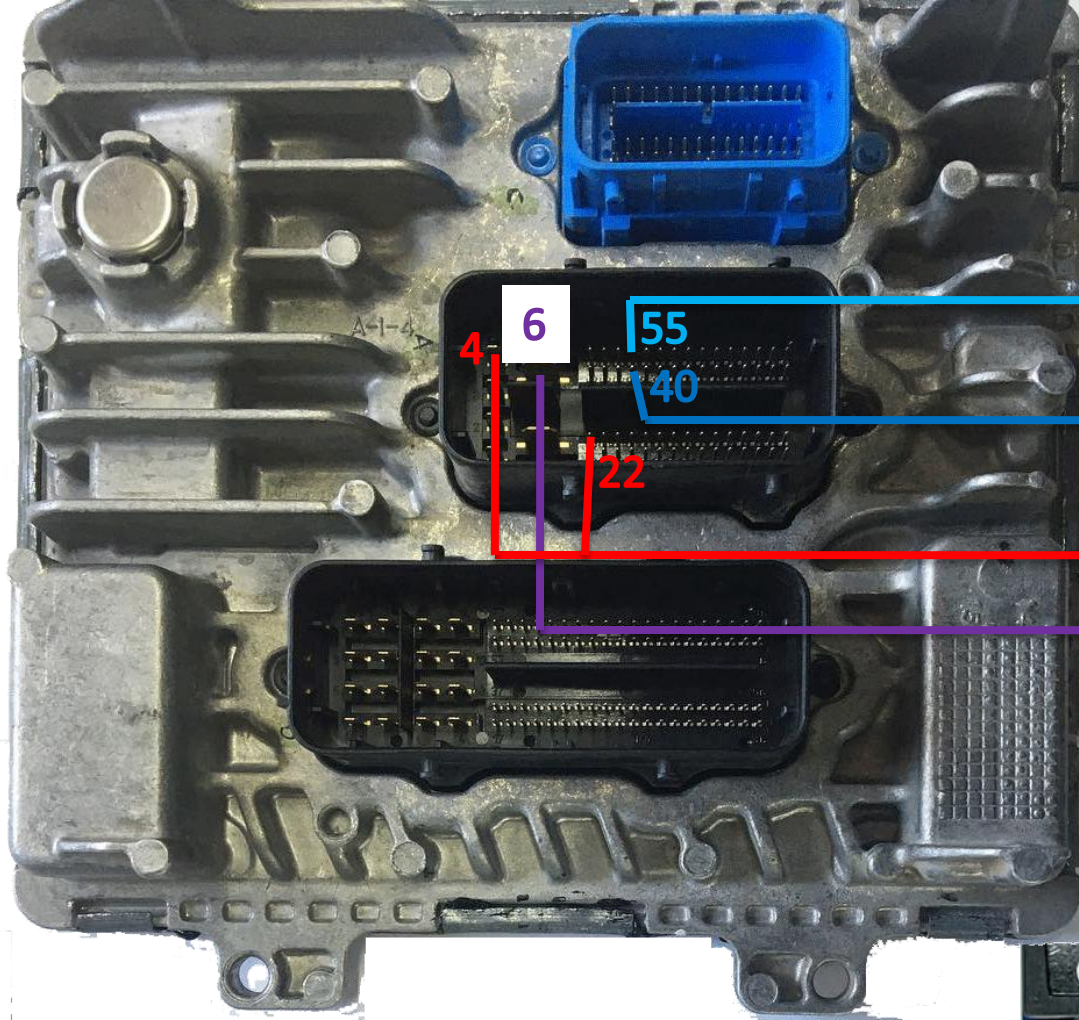

[Regresar al menú](#)

www.scanator.com.mx/alimentadora

DELPHI
DCM3.7AP

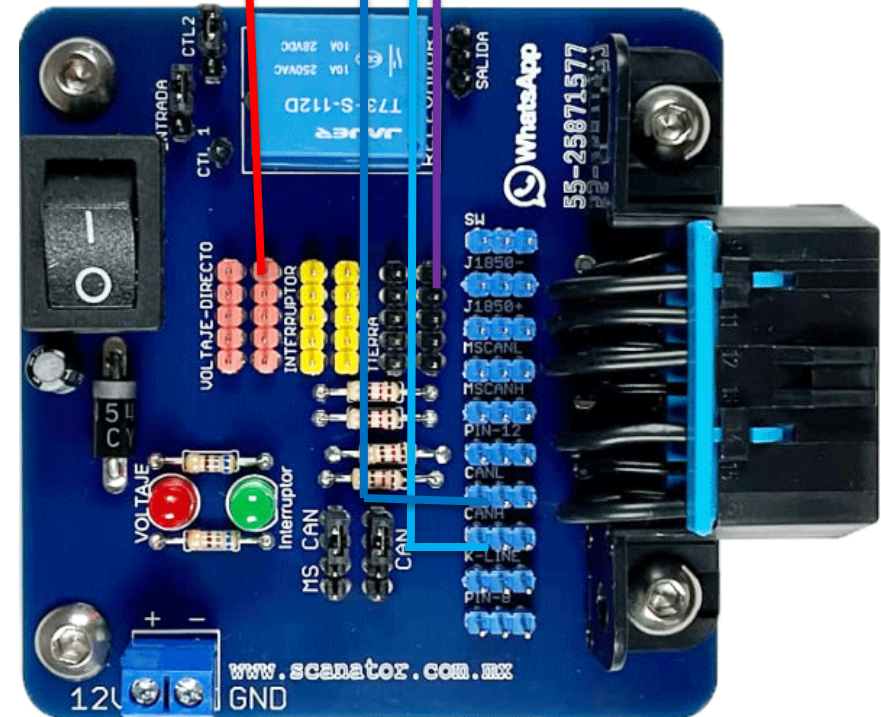
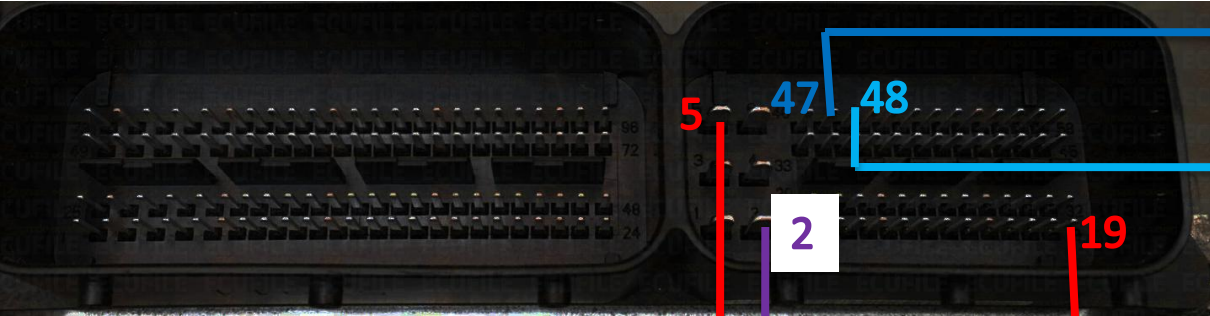

[Regresar al menú](#)

www.scanator.com.mx/alimentadora

Acdelco e83

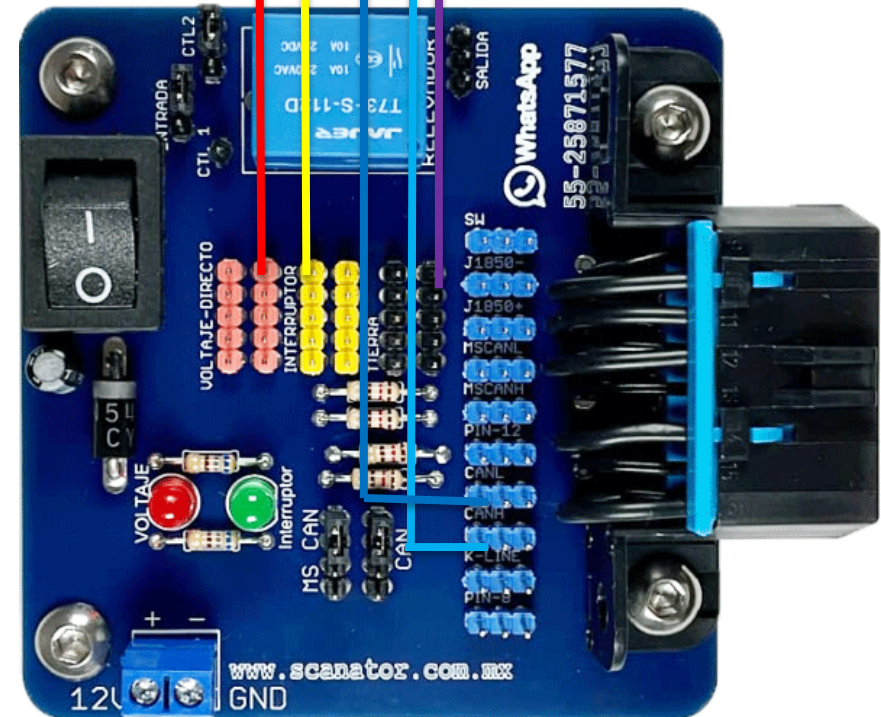
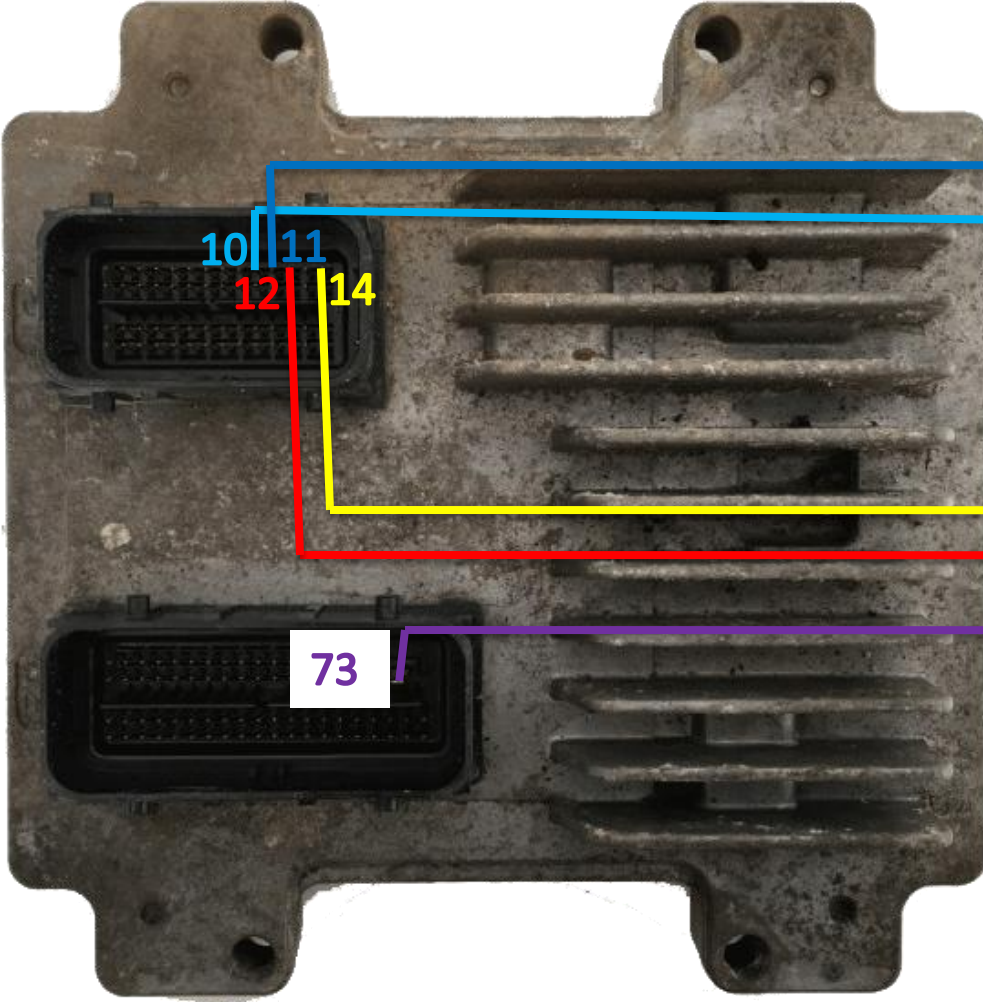

[Regresar al menú](#)

www.scanator.com.mx/alimentadora

Accelco e82

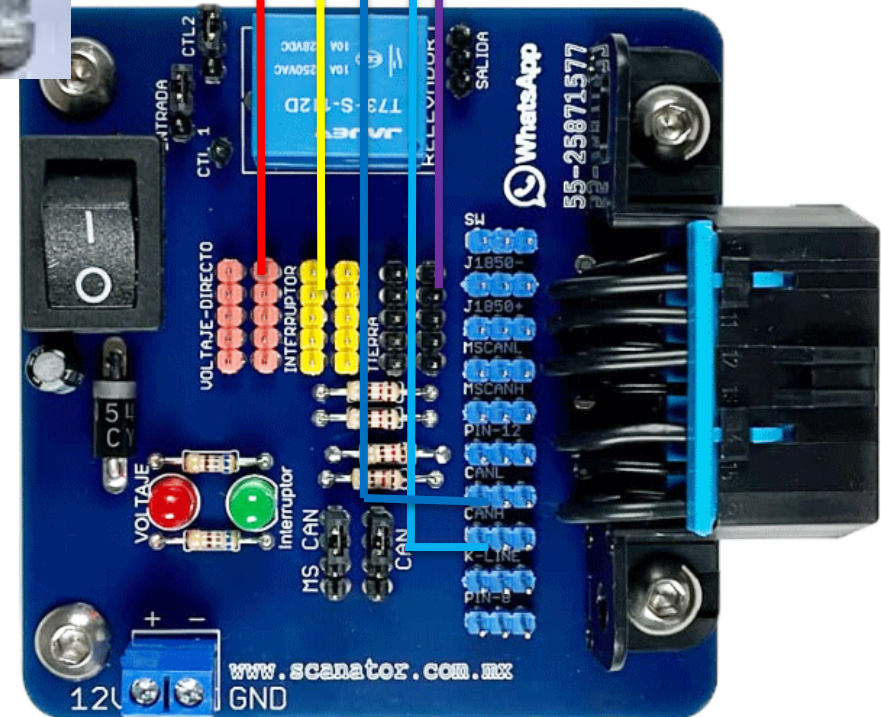
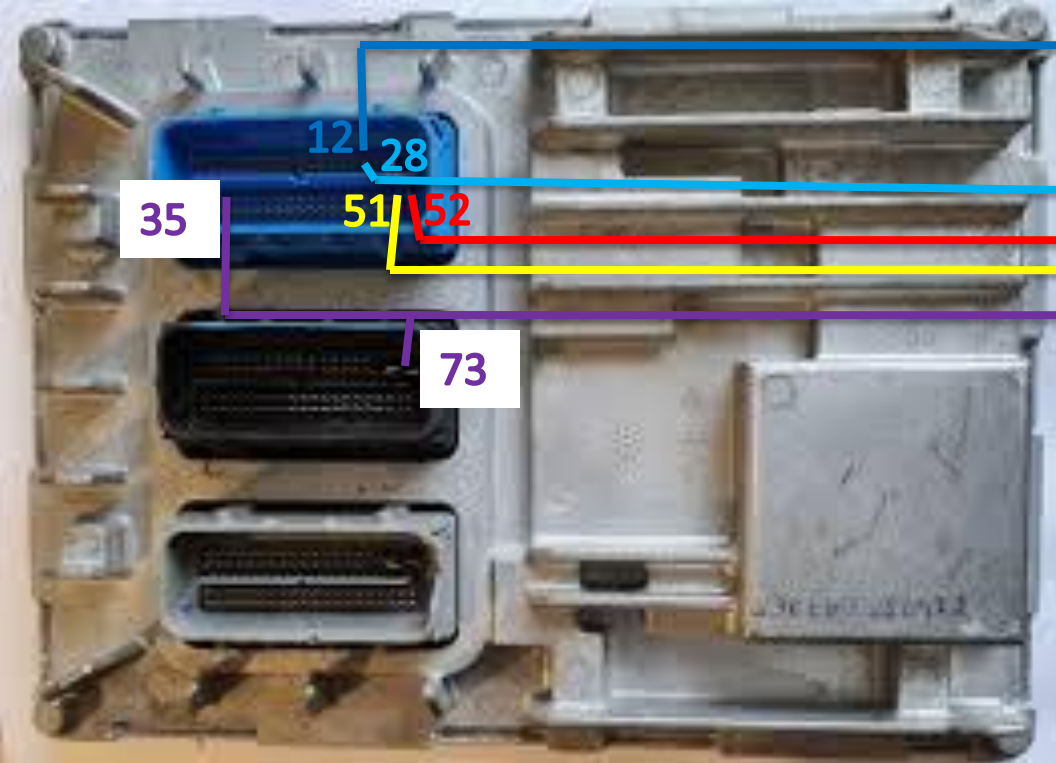

[Regresar al menú](#)

www.scanator.com.mx/alimentadora

Accelco e87

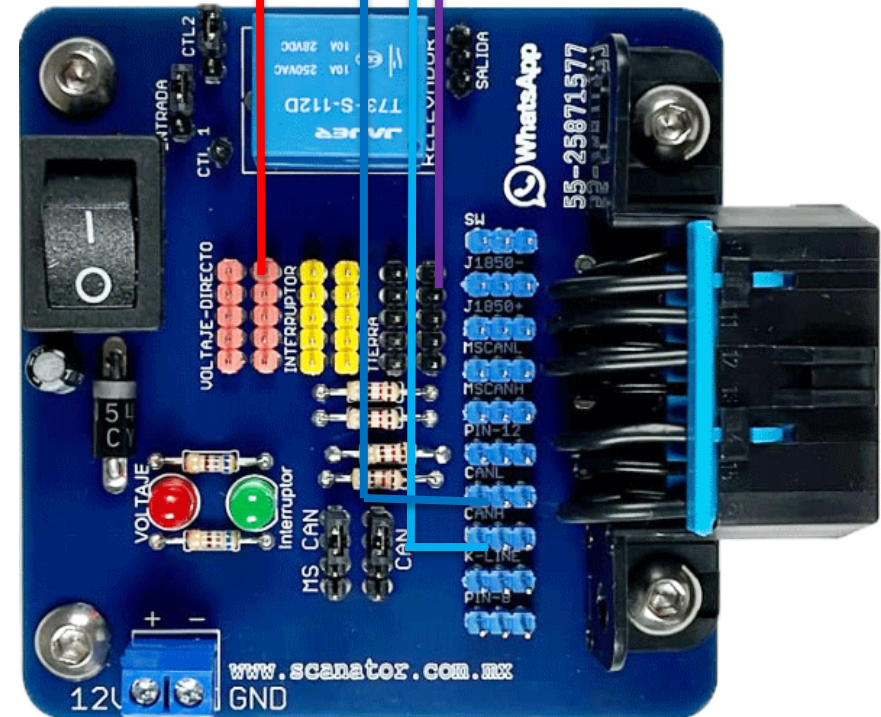
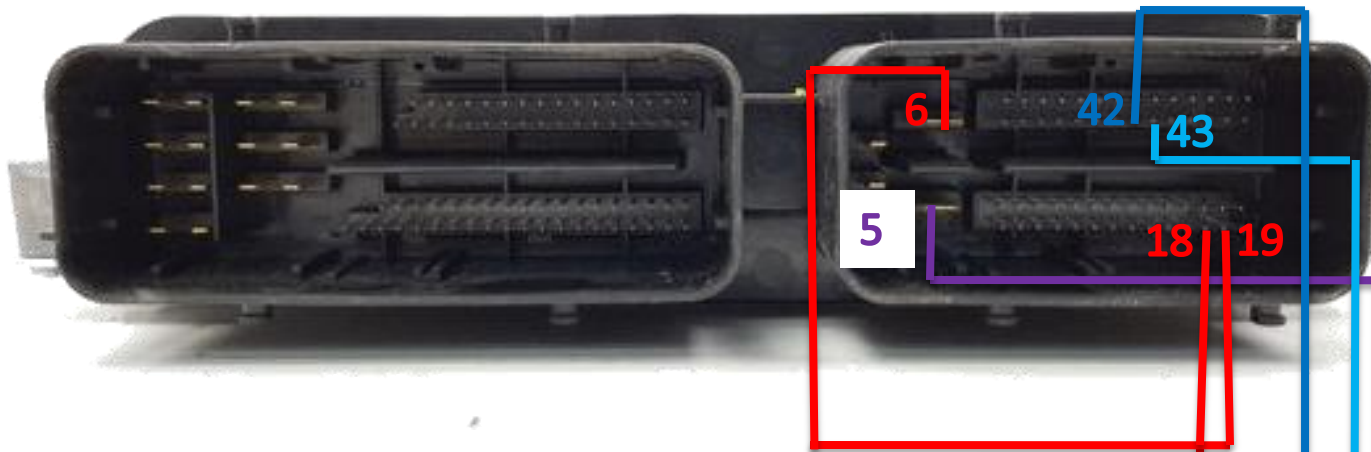

[Regresar al menú](#)

www.scanator.com.mx/alimentadora

Acdelco e78

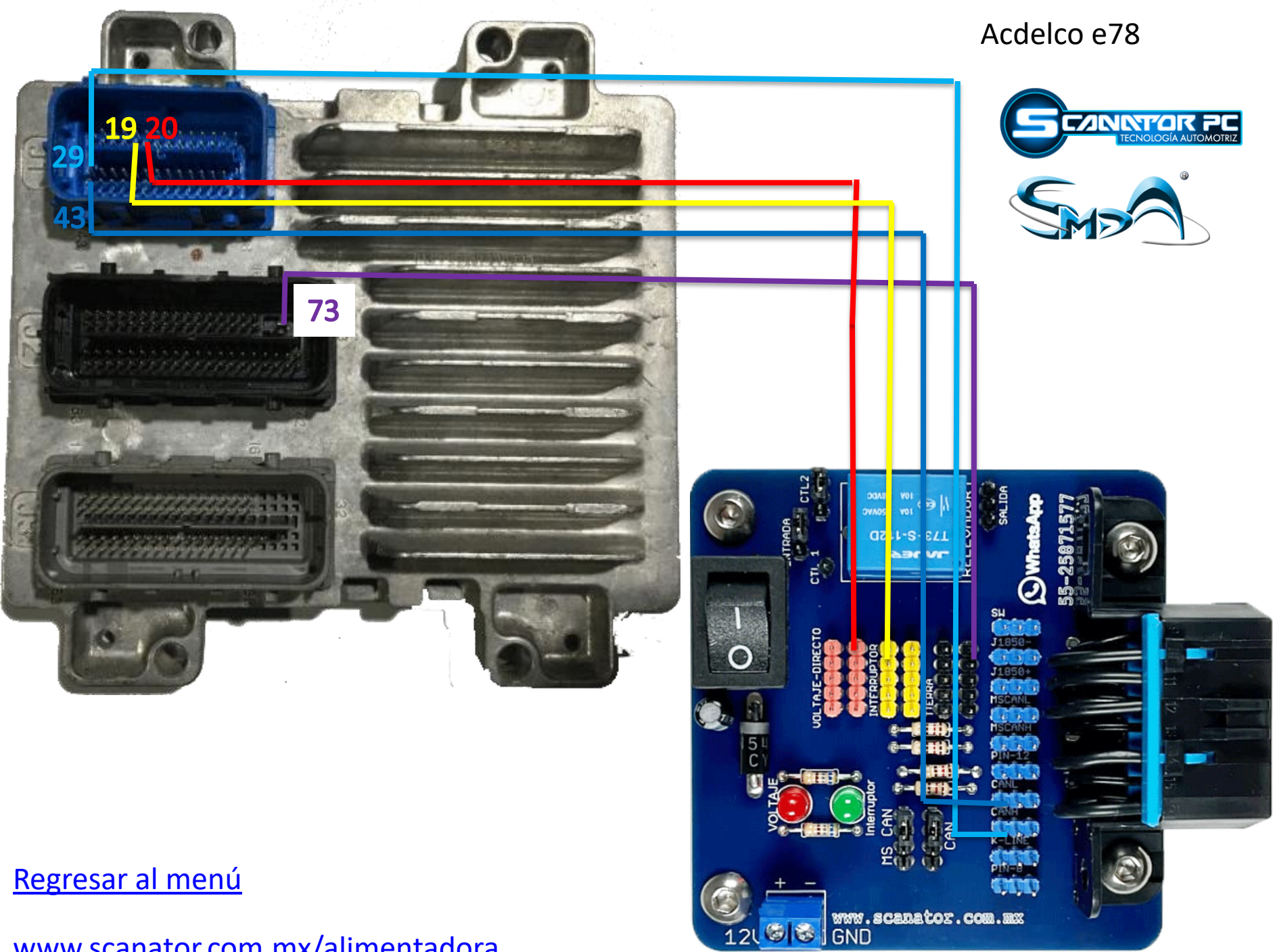

[Regresar al menú](#)

www.scanator.com.mx/alimentadora

Acdelco e39 /
e39a

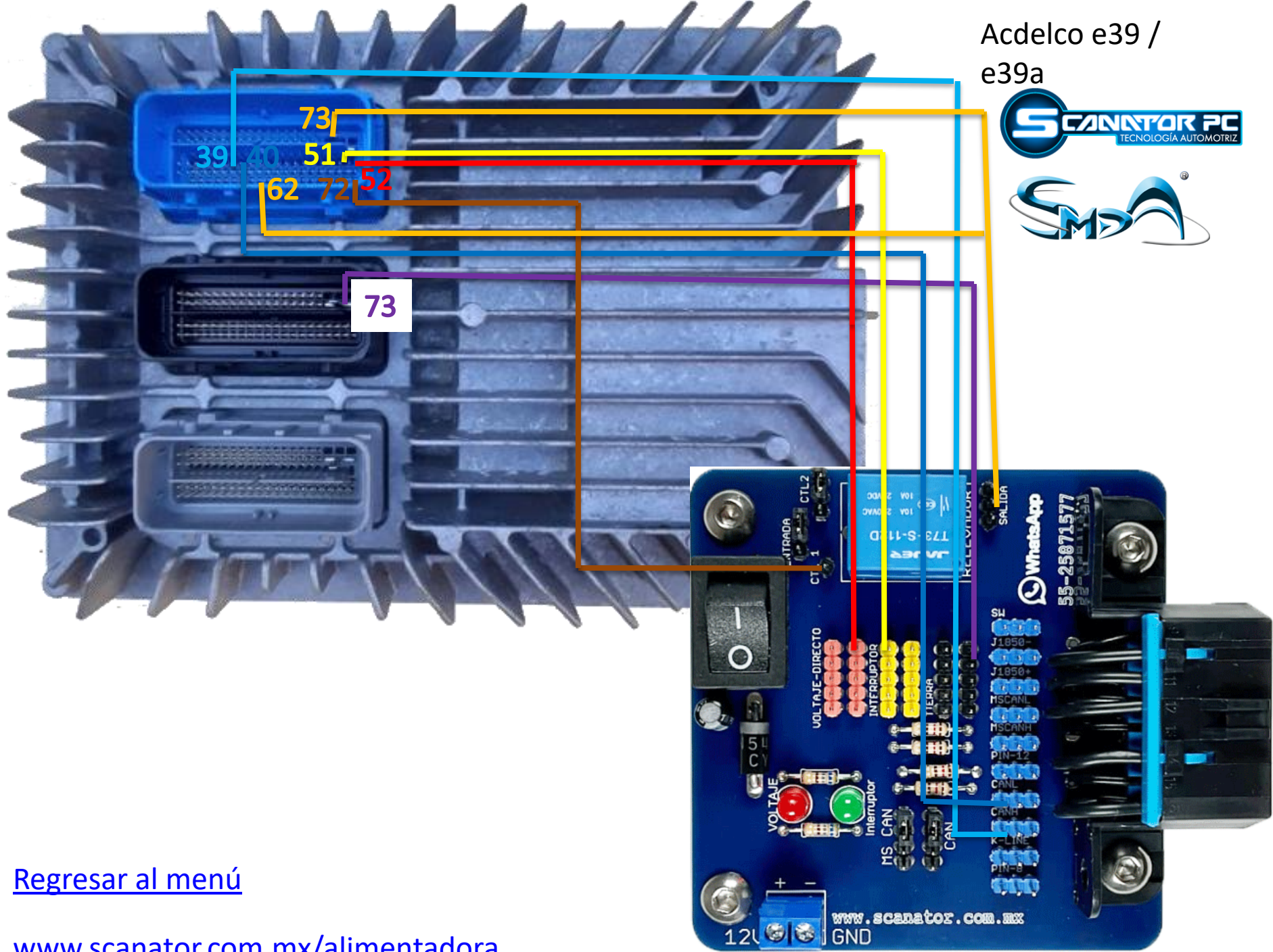

[Regresar al menú](#)

www.scanator.com.mx/alimentadora

Accelco e92

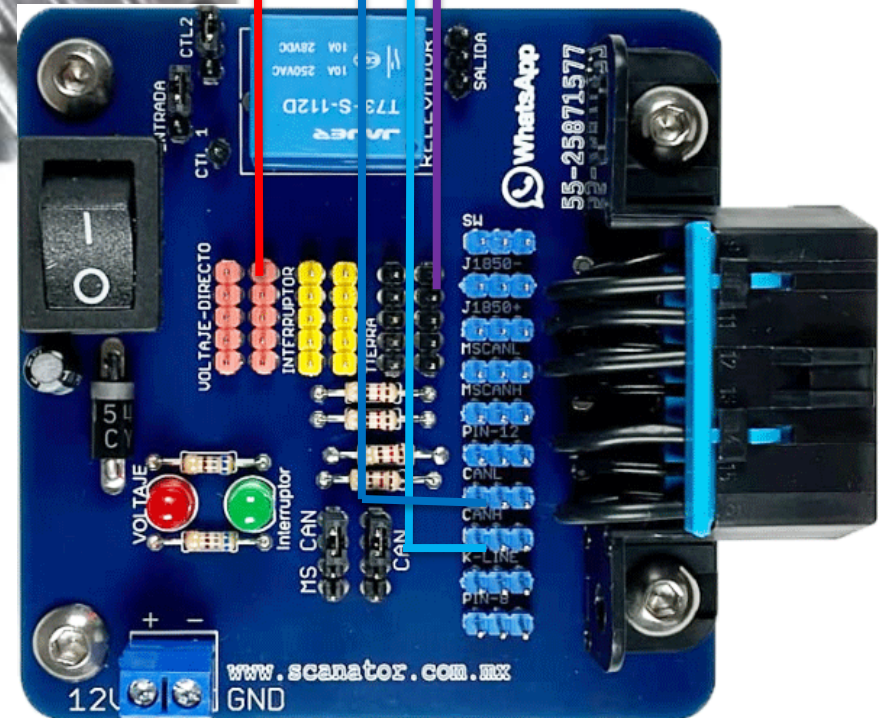
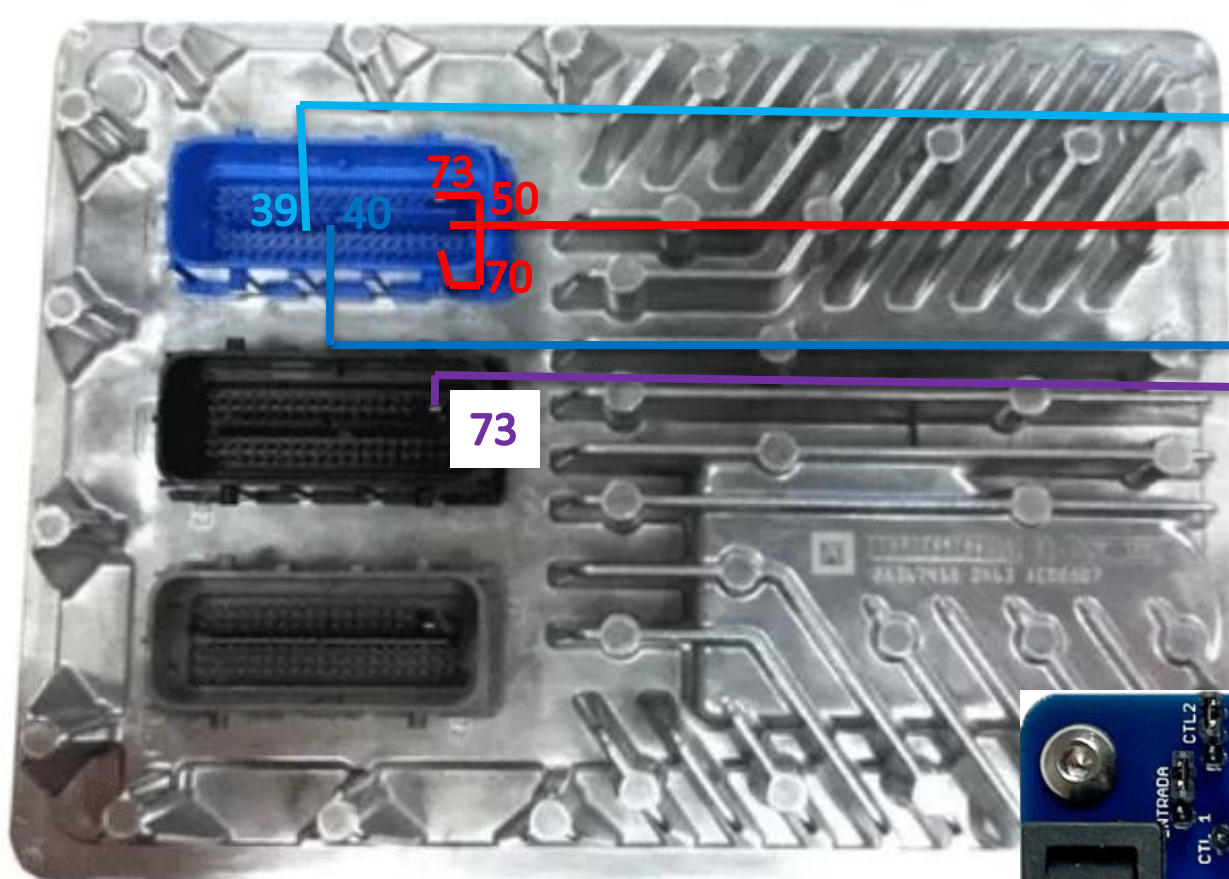

[Regresar al menú](#)

www.scanator.com.mx/alimentadora

Acdelco e80

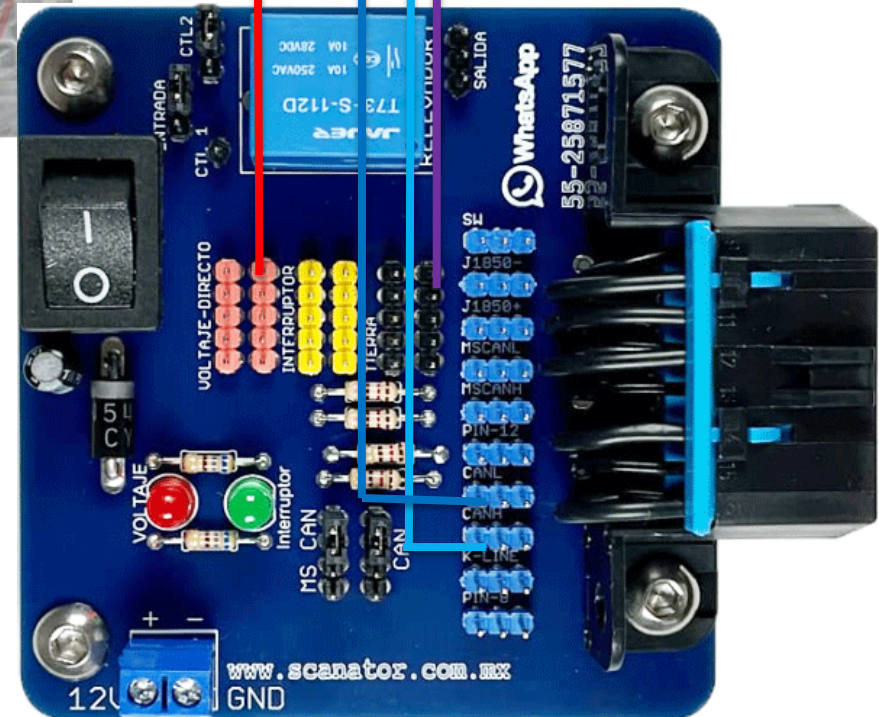
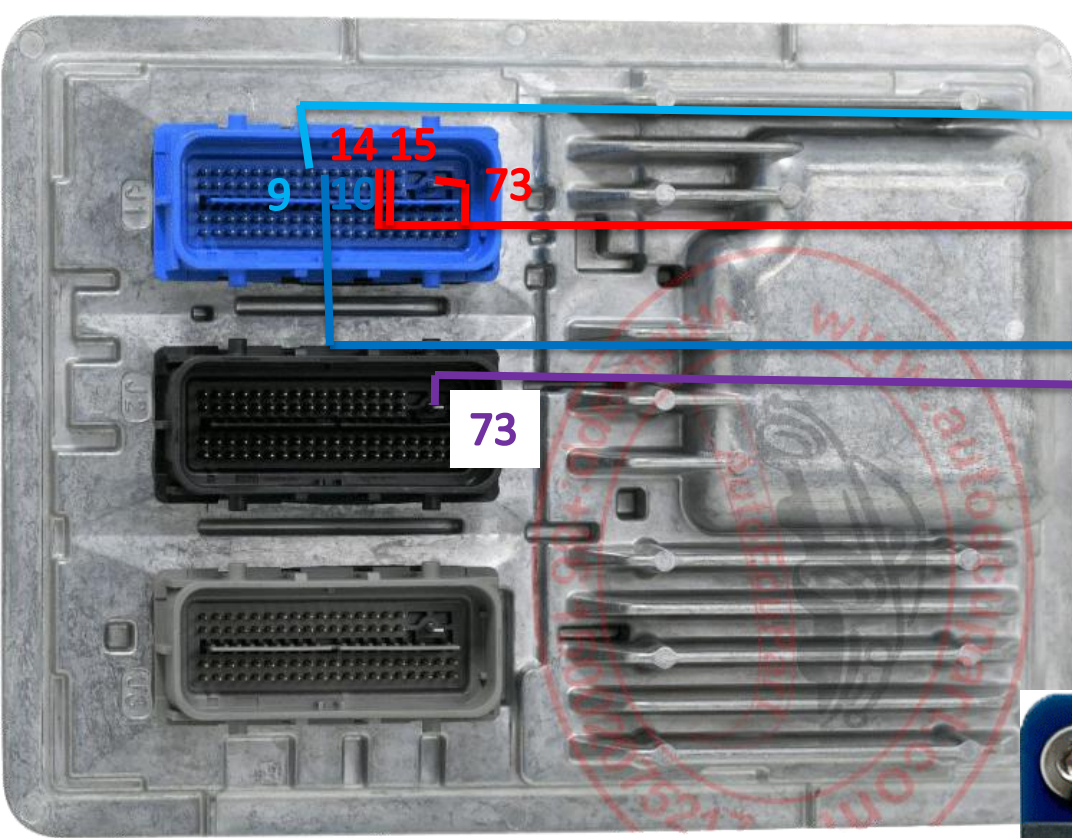

[Regresar al menú](#)

www.scanator.com.mx/alimentadora

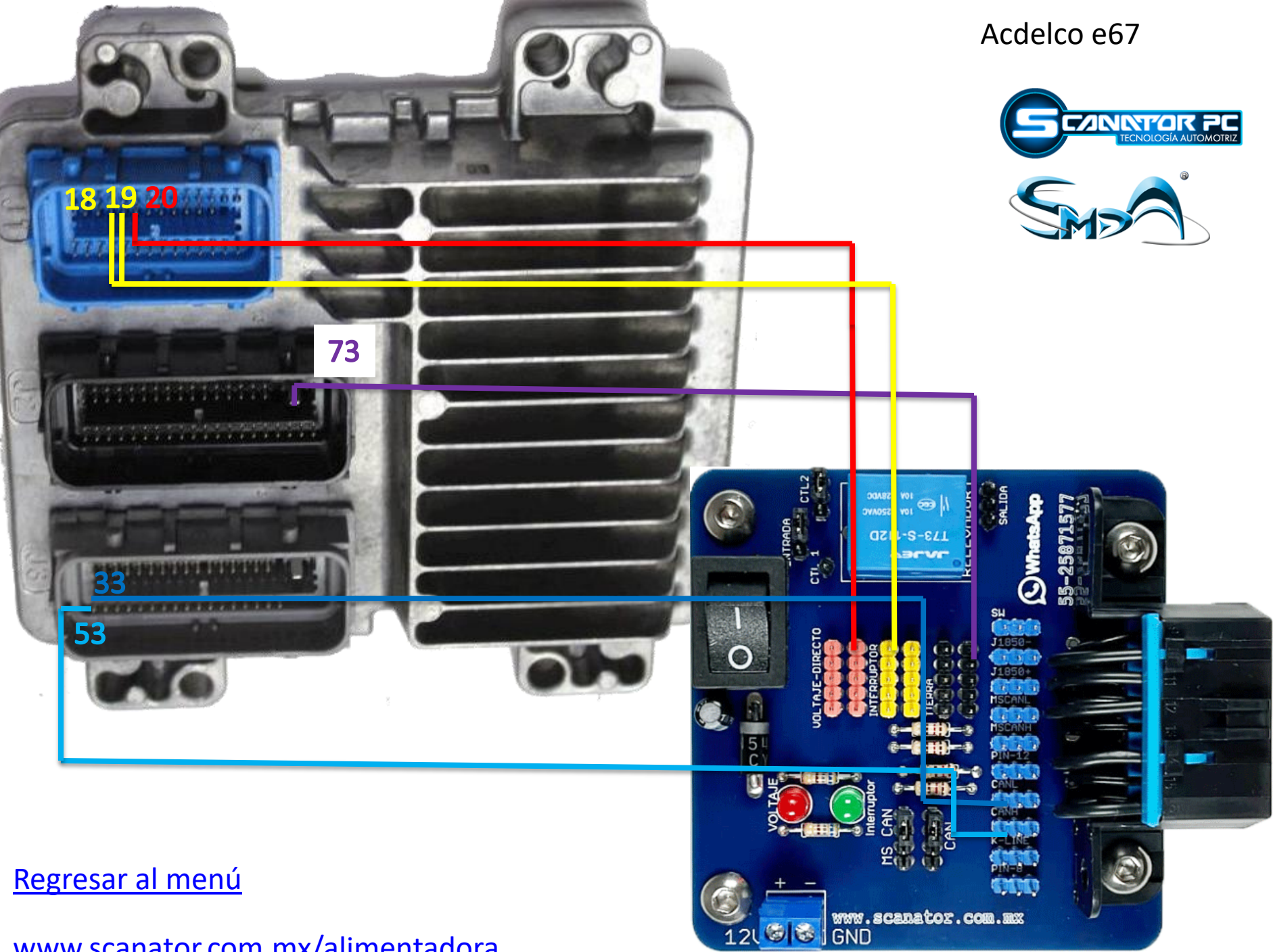

18 19 20

73

33

53

[Regresar al menú](#)

www.scanator.com.mx/alimentadora

TCM 6T30,6T35,
6T40,6T45,6T50



[Regresar al menú](#)

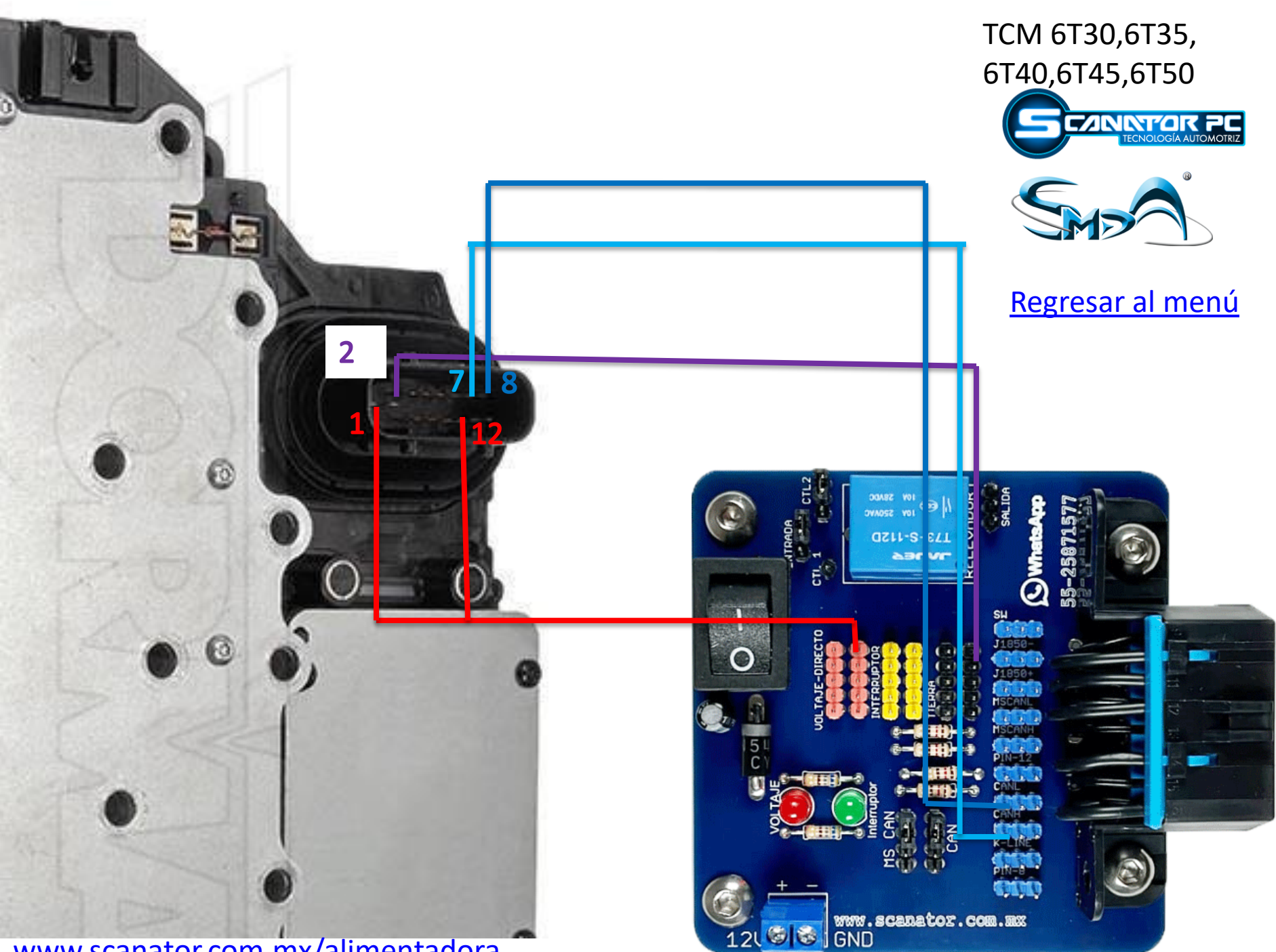

TCM 6T70,6T75,
6T80

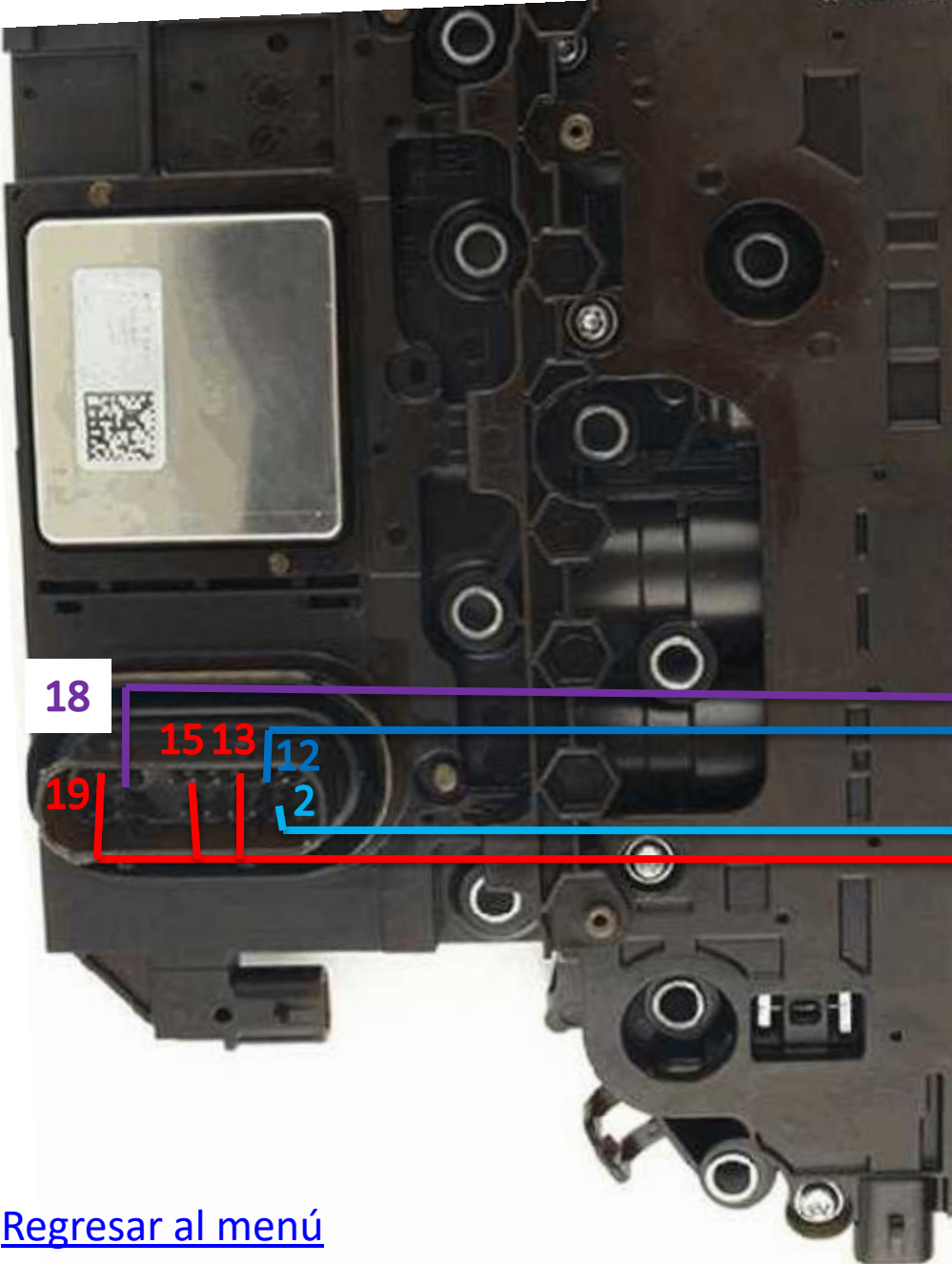

18

15 13

12
2

19

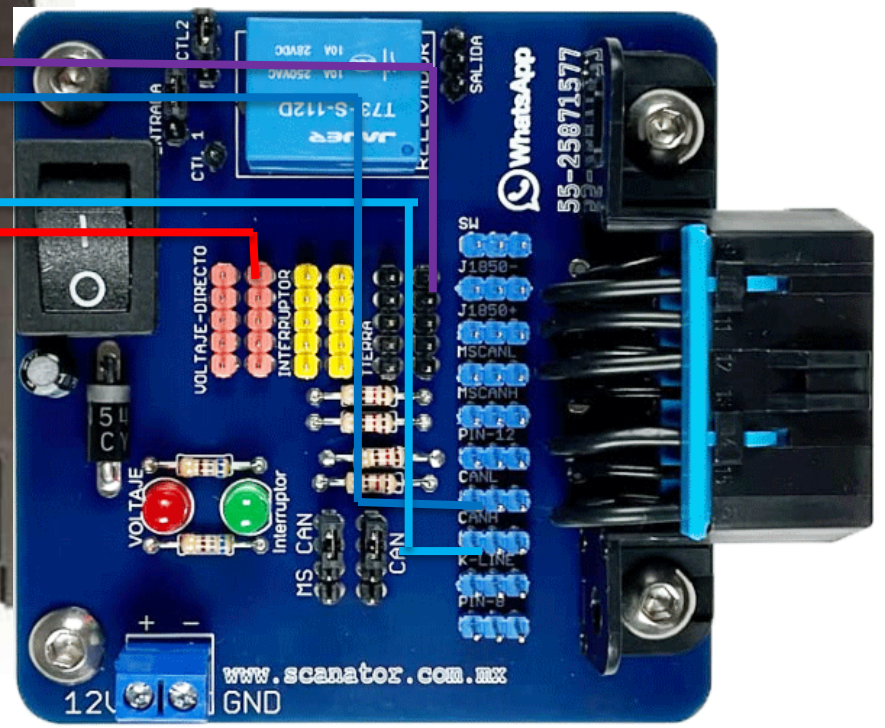

[Regresar al menú](#)

www.scanator.com.mx/alimentadora

TCM 6L45, 6L50,
6L80, 6L90

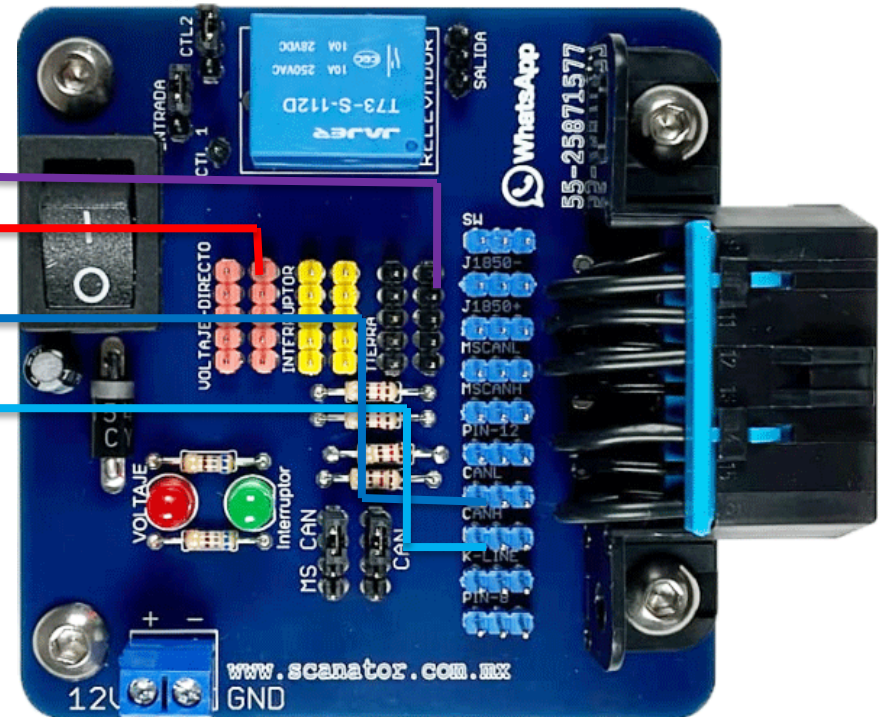
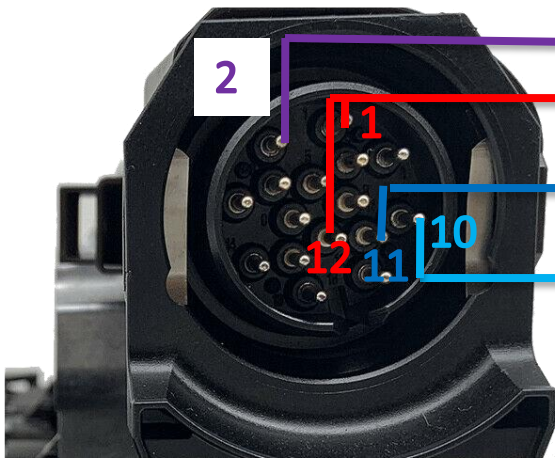
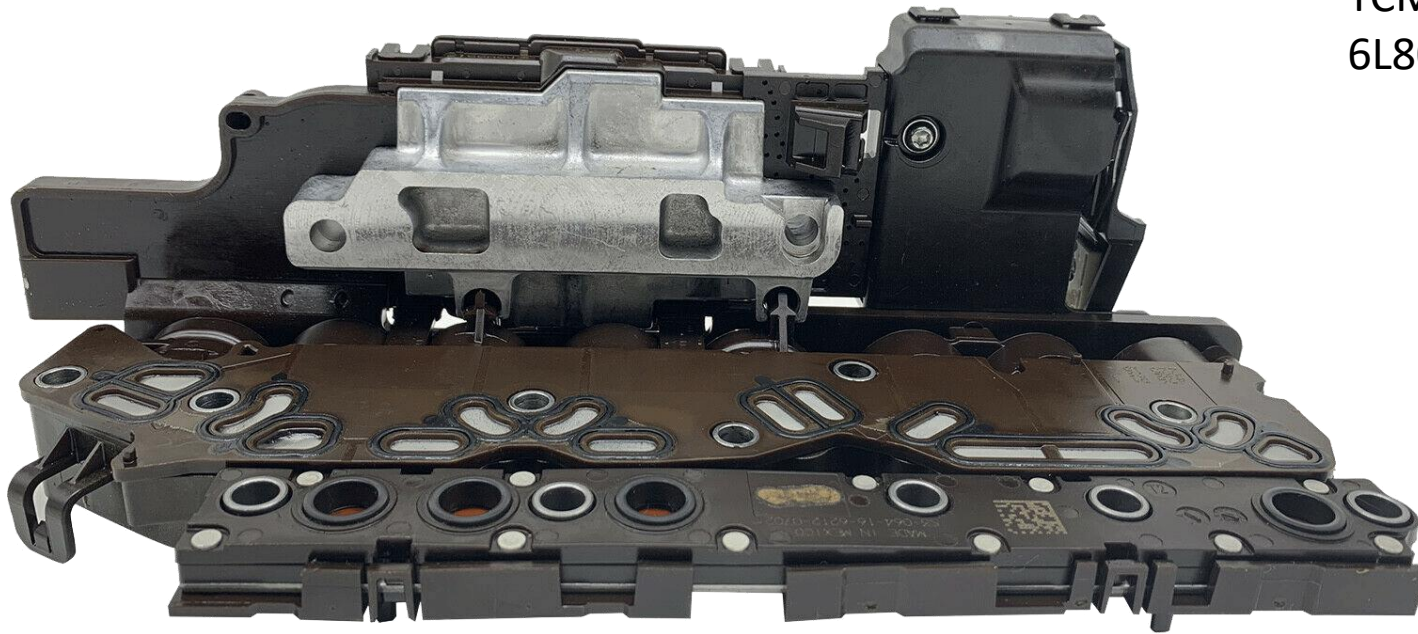

[Regresar al menú](#)

www.scanator.com.mx/alimentadora

Conexión Z14XE Corsa 2002 - 2003

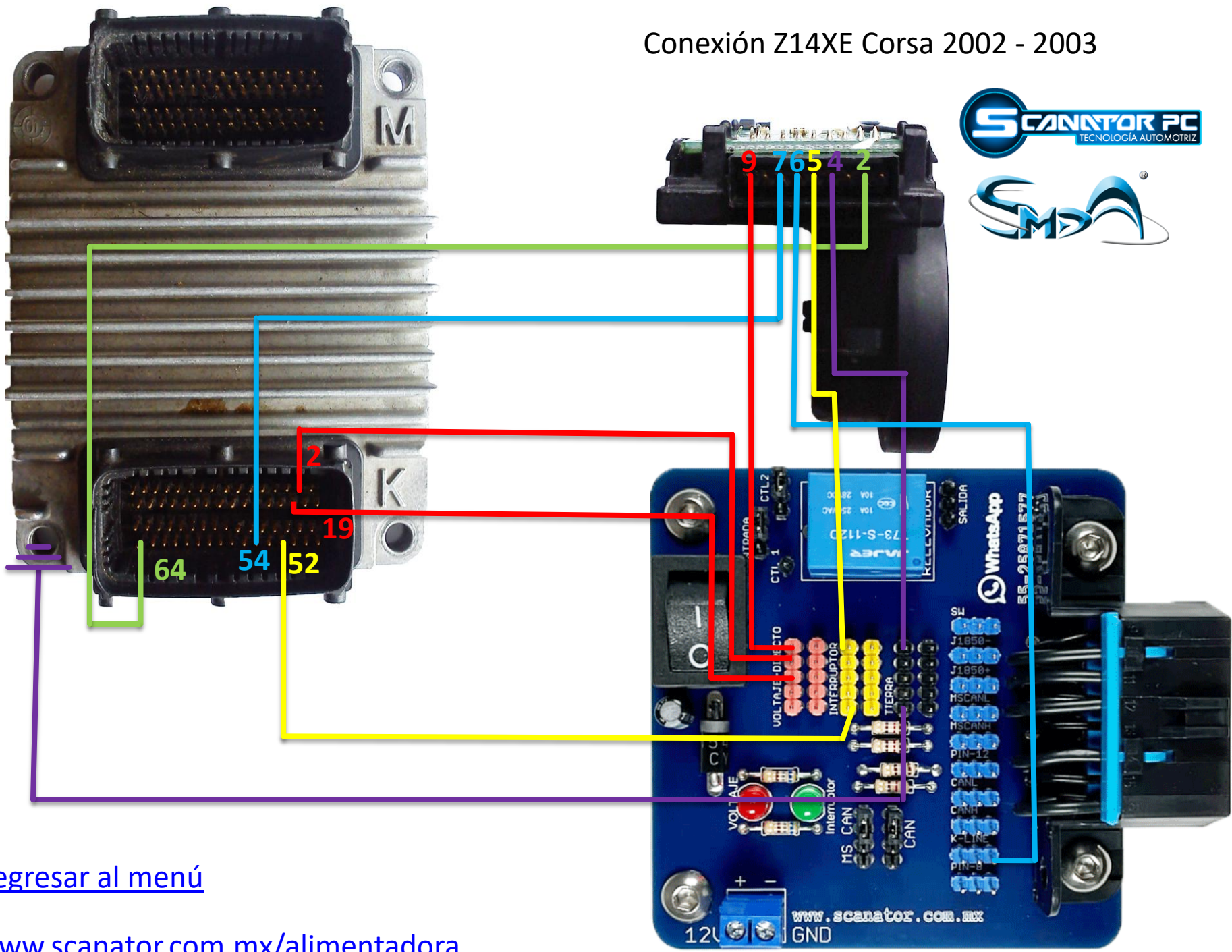

[Regresar al menú](#)

www.scanator.com.mx/alimentadora

Conexión ECU Chevy con inmo 2006 en adelante

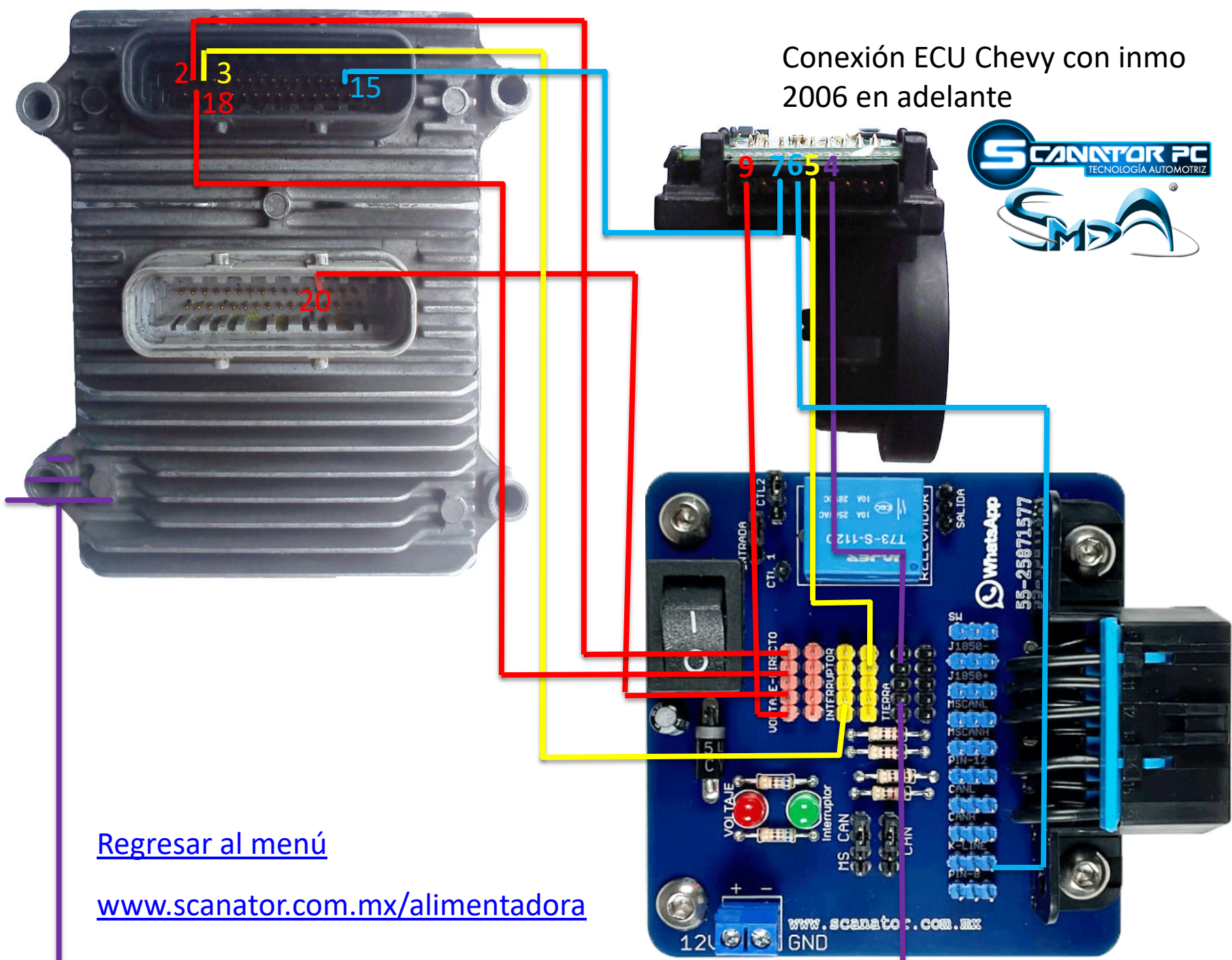

[Regresar al menú](#)

www.scanator.com.mx/alimentadora

Conexión ECU Chevy sin inmo 2004 y 2005

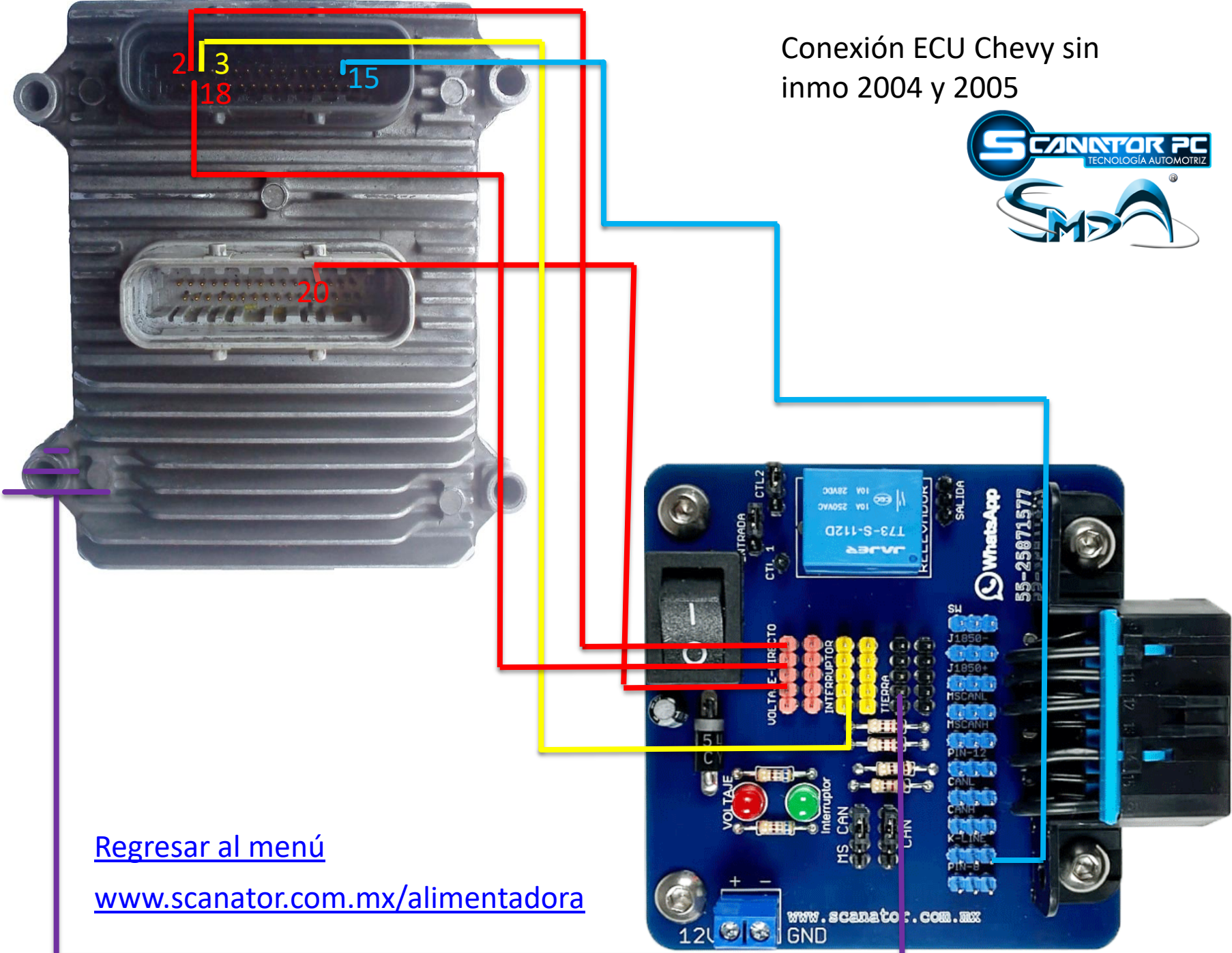

[Regresar al menú](#)

www.scanator.com.mx/alimentadora

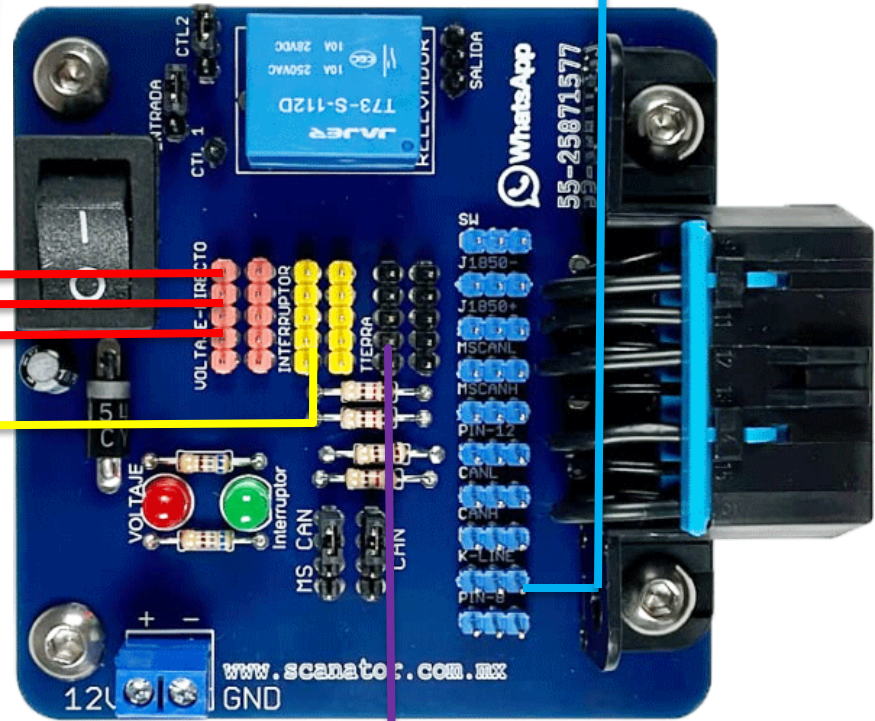

Conexión C18NE1 MERIVA 2004 -2005

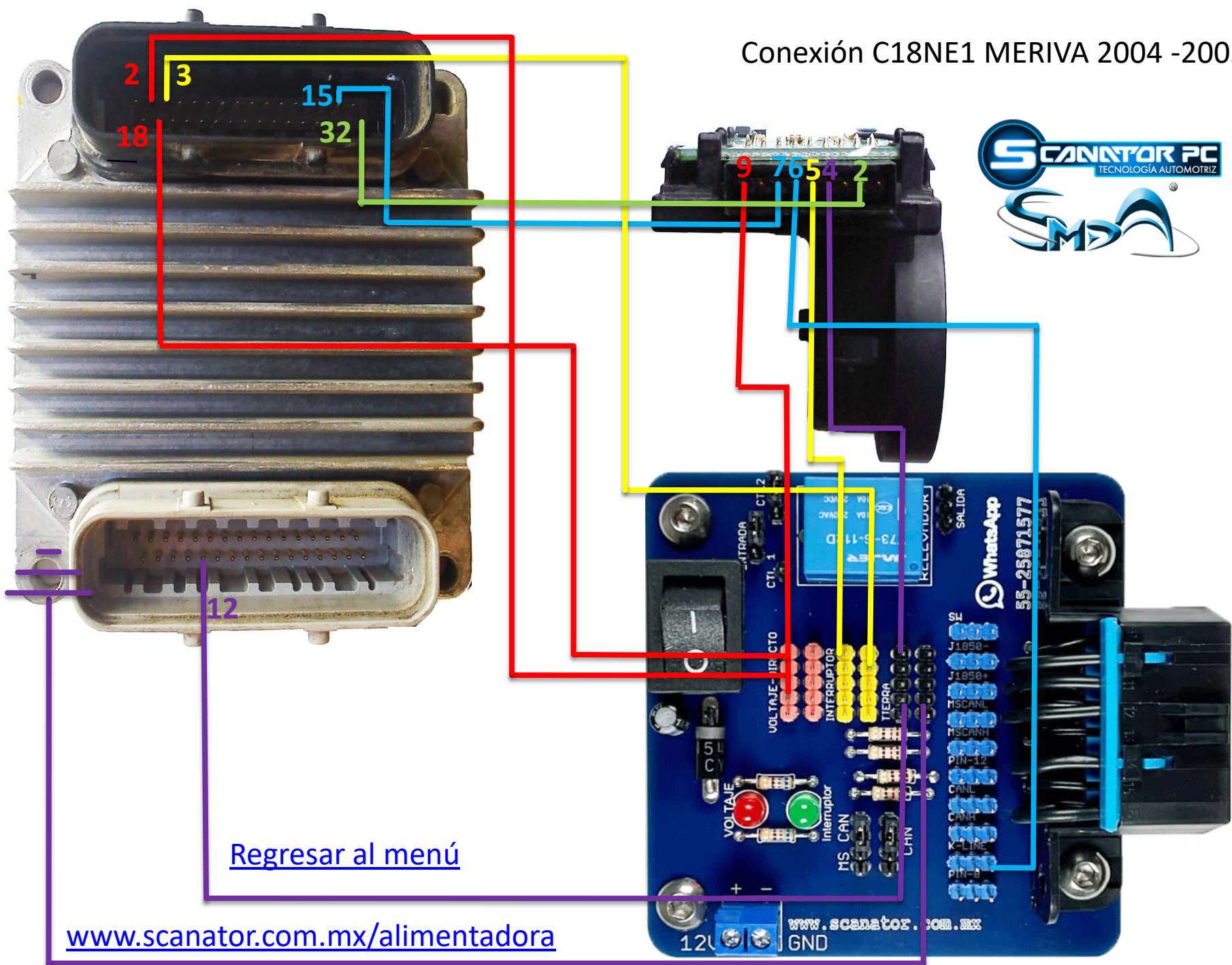

[Regresar al menú](#)

www.scanator.com.mx/alimentadora

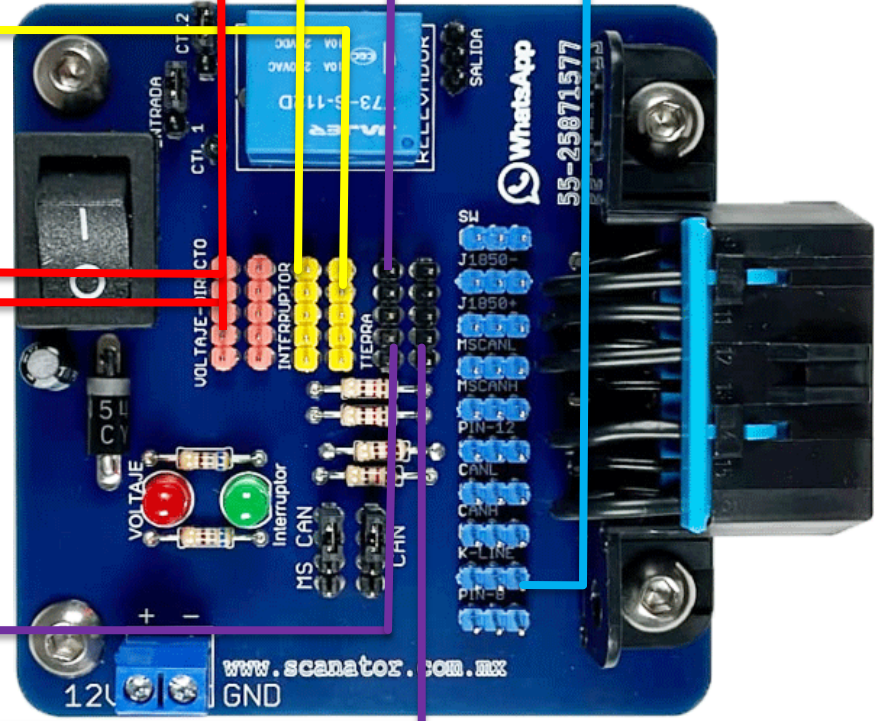

Conexión T18NE1 y X18NE1

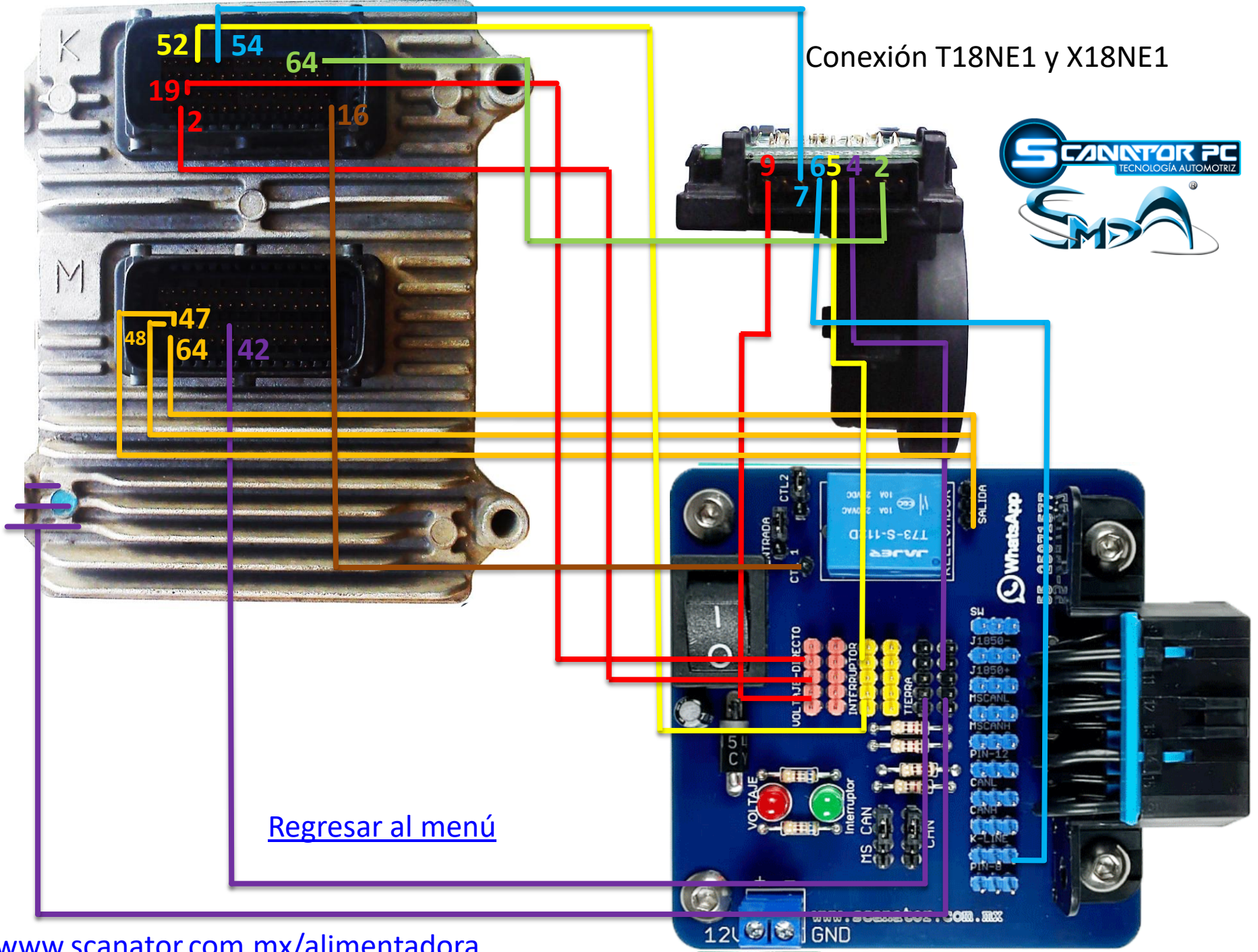

[Regresar al menú](#)

Conexión Z18XE Astra 2001-2003 Simtec 71

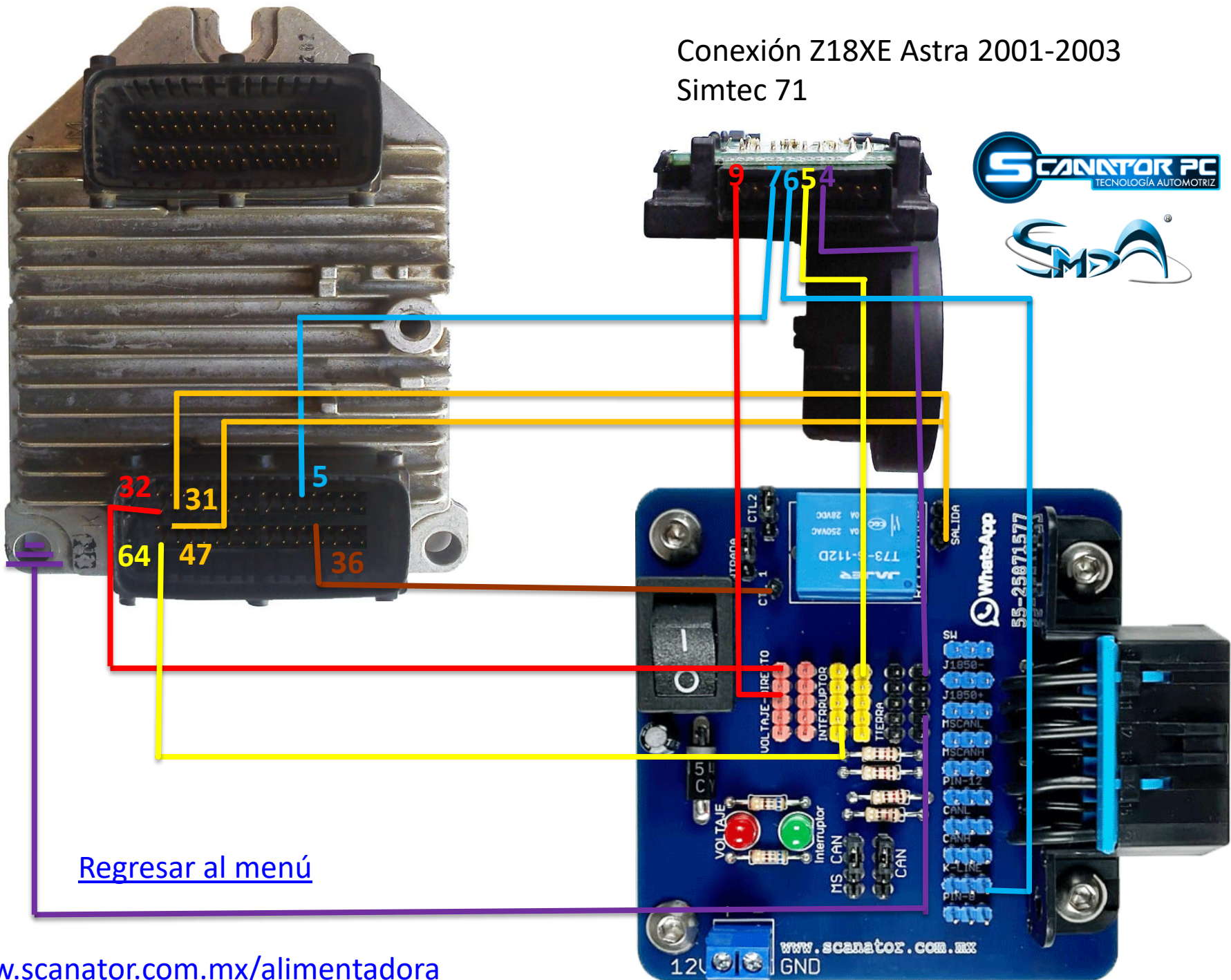

[Regresar al menú](#)

Conexión Z18XE Astra 2001-2003
Meriva 2007-2008
Simtec 71.1

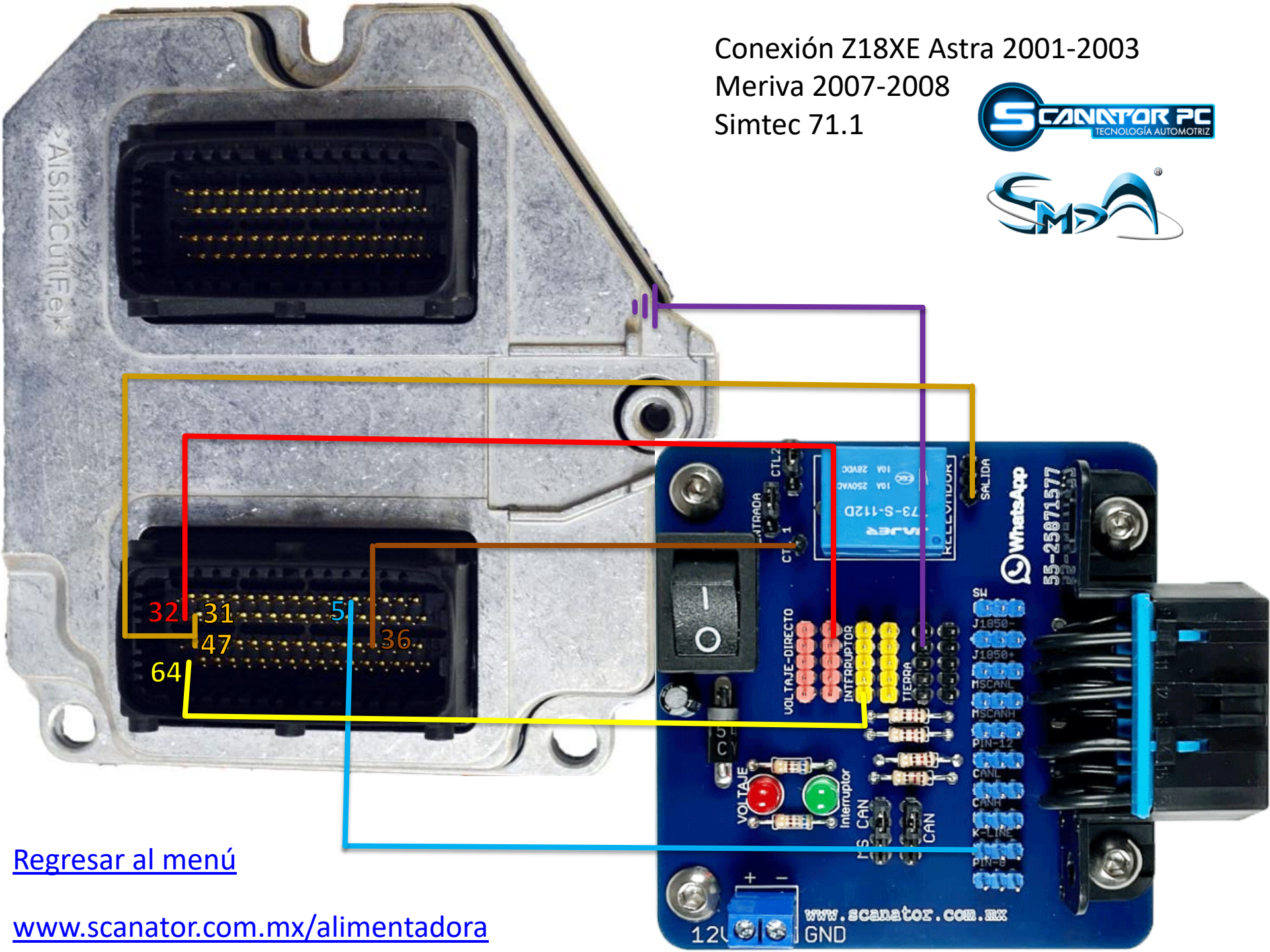

[Regresar al menú](#)

www.scanator.com.mx/alimentadora

Conexión Z18XE Astra H 2007 Simtec 71.6

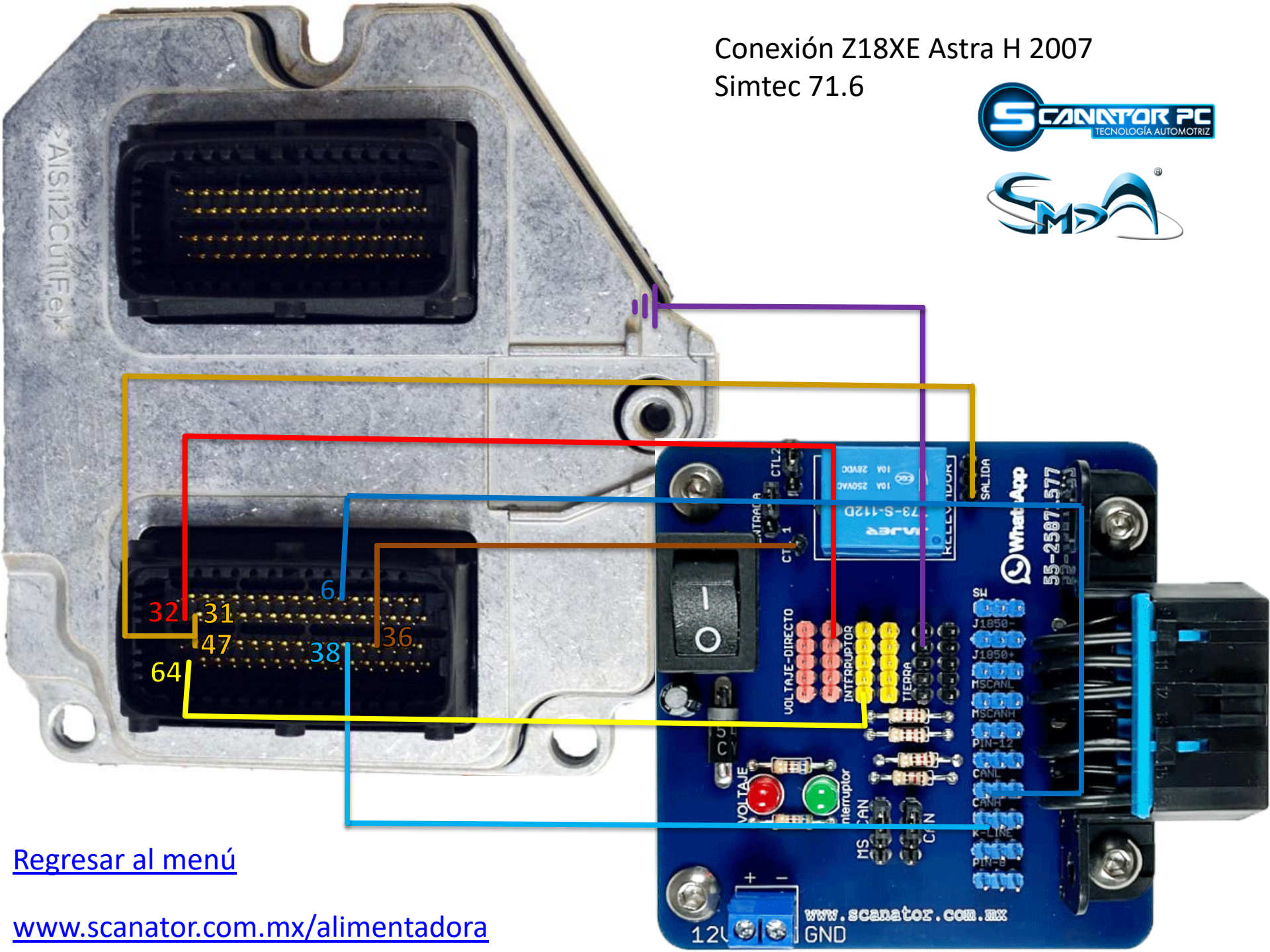

[Regresar al menú](#)

www.scanator.com.mx/alimentadora

Conexión X18XE Astra 2000 - 2001

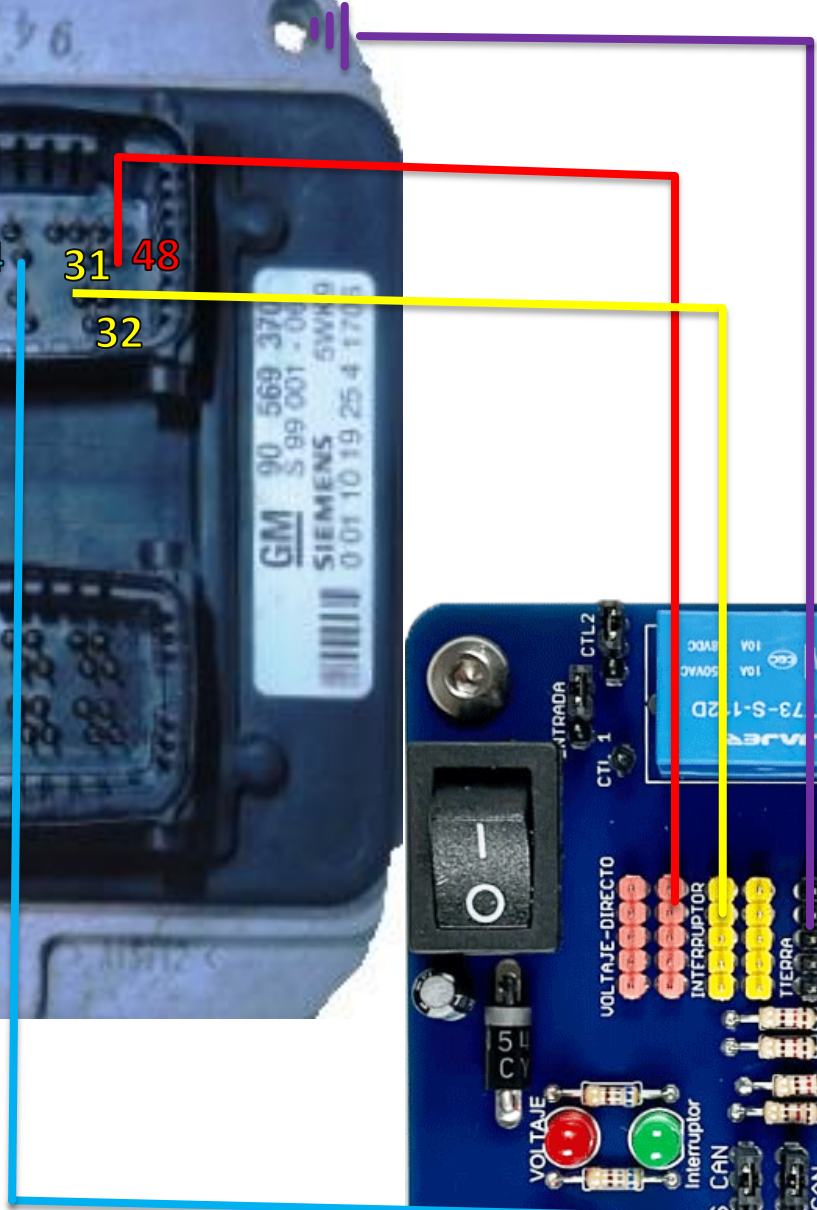
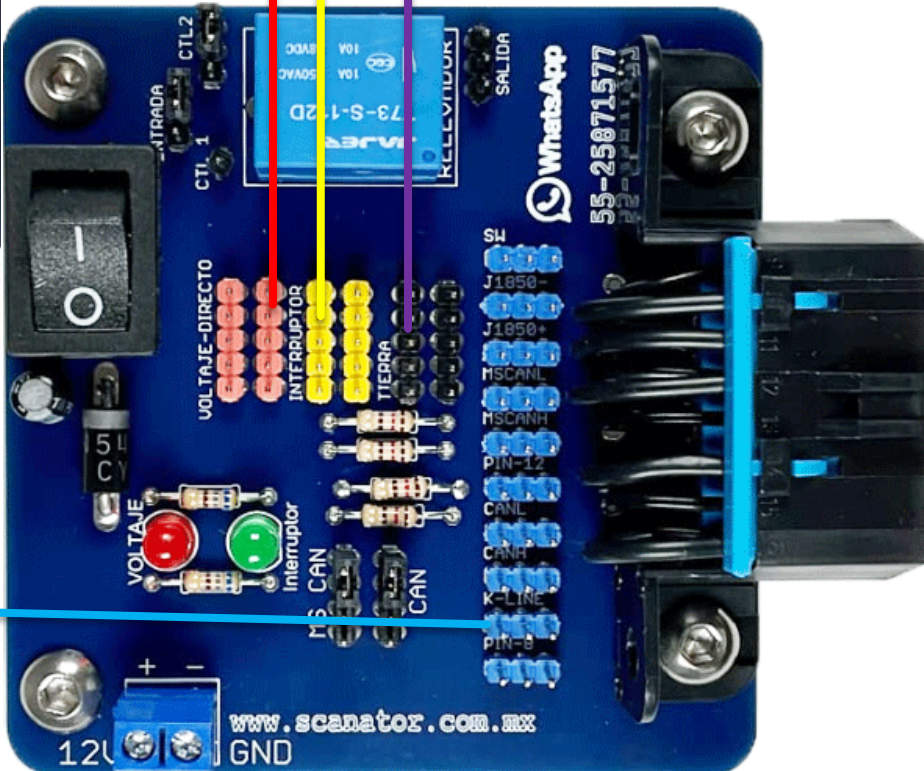
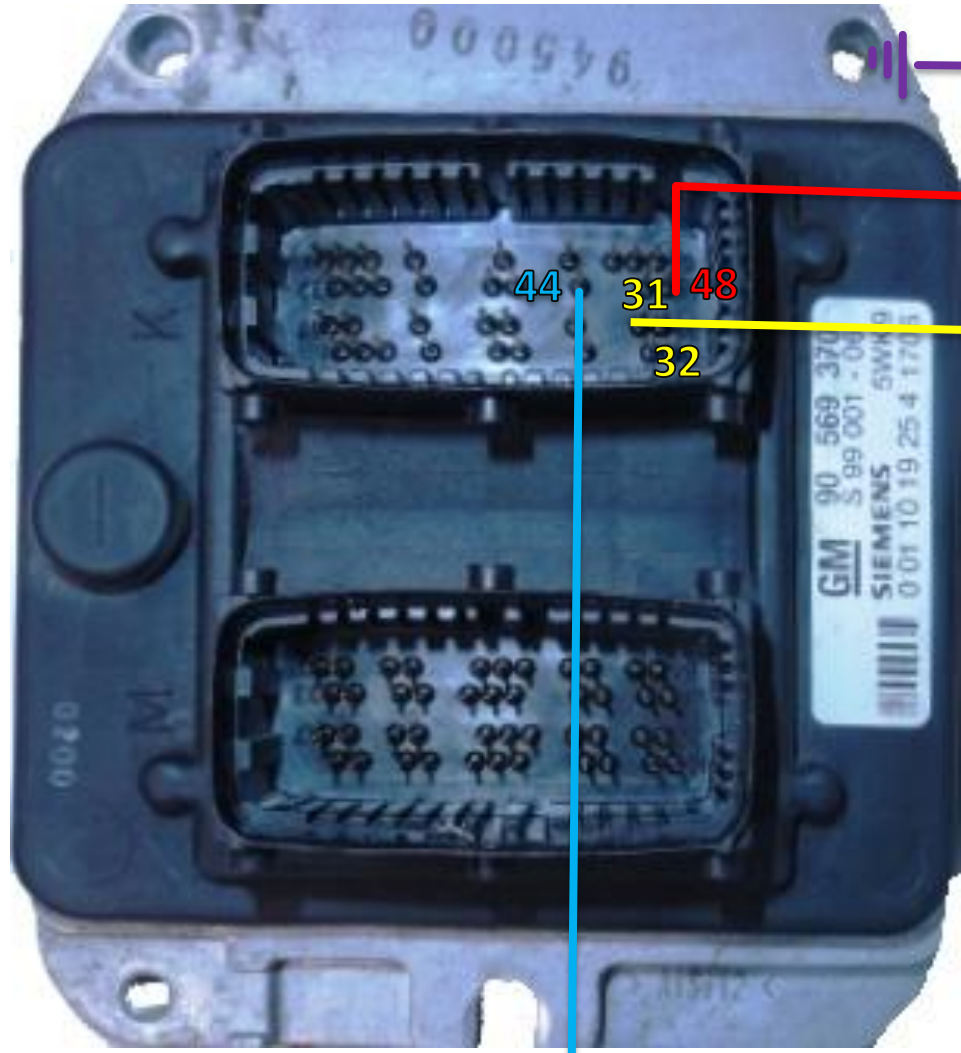

[Regresar al menú](#)

www.scanator.com.mx/alimentadora

Conexión X24SE Astra

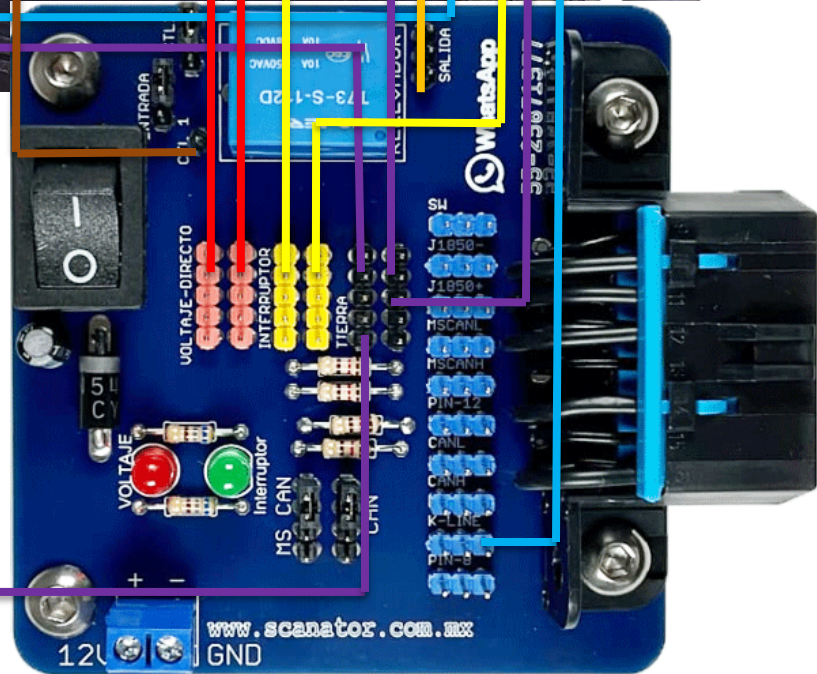
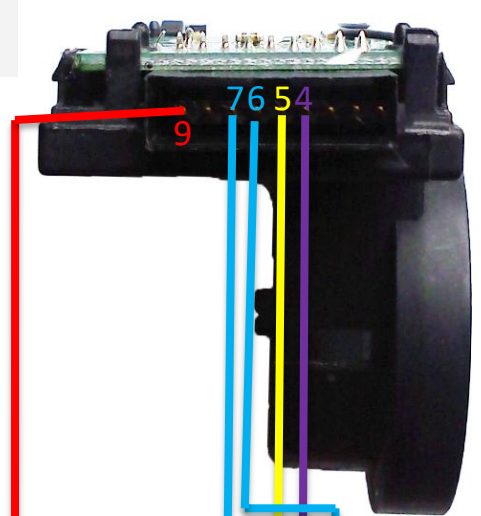
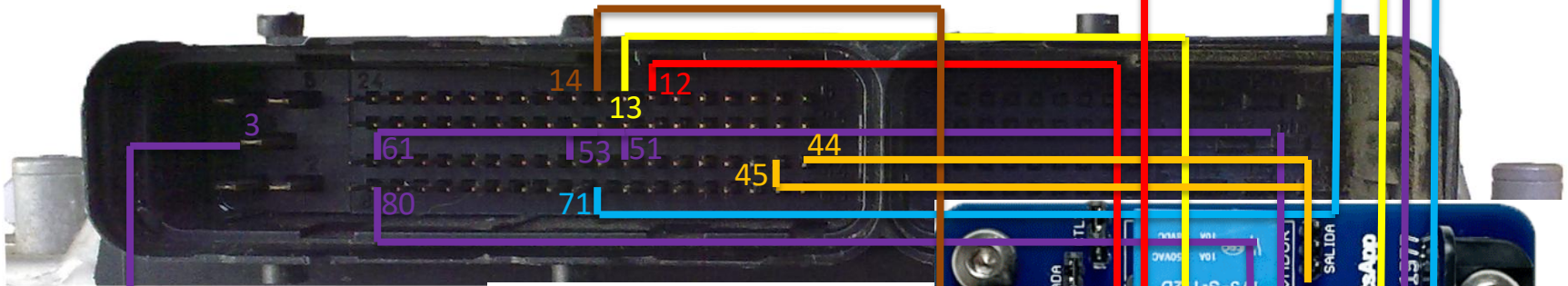

[Regresar al menú](#)

Conexión Z22SE Astra y Zafira

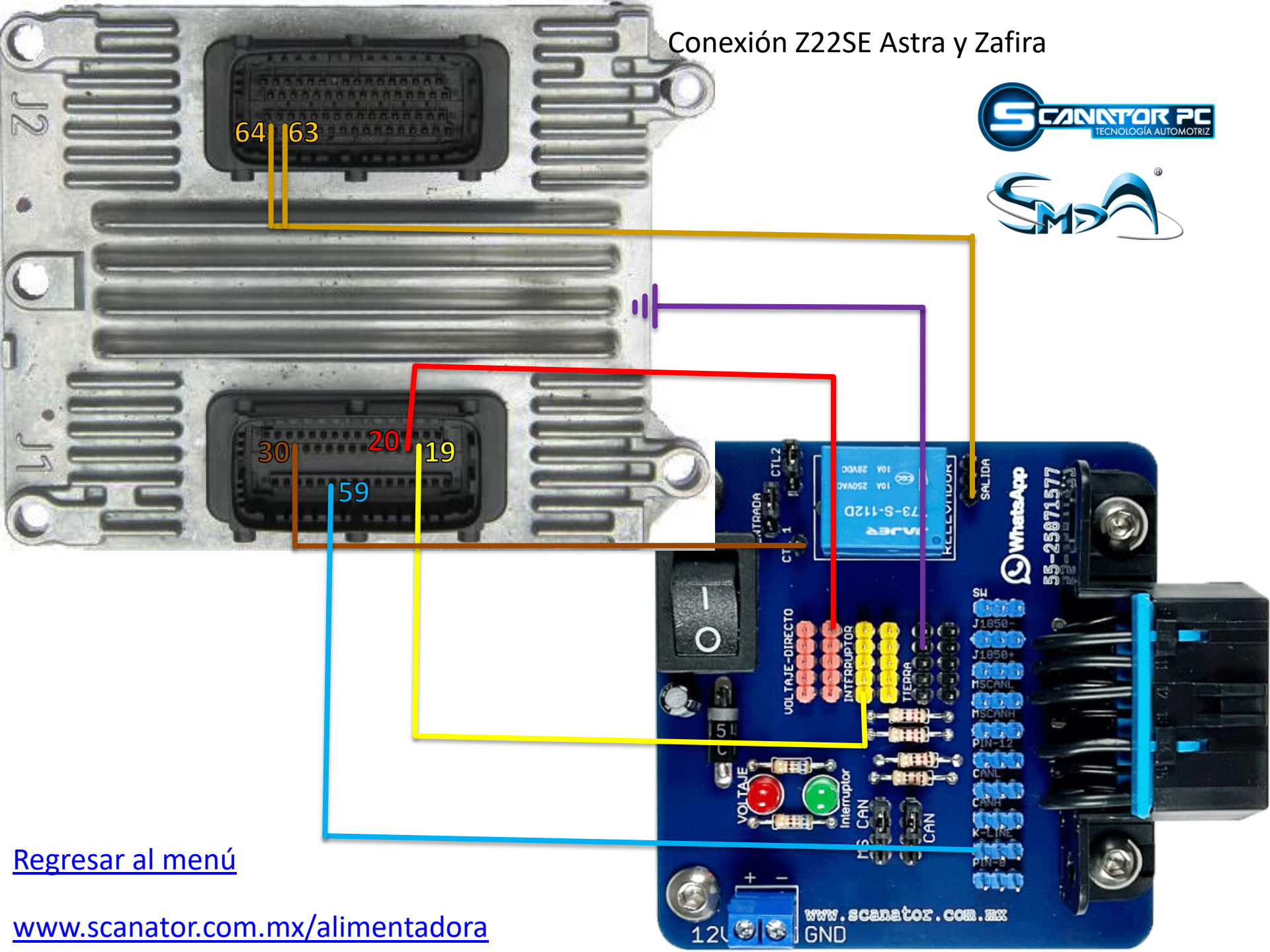

[Regresar al menú](#)

www.scanator.com.mx/alimentadora

Conexión Cobalt

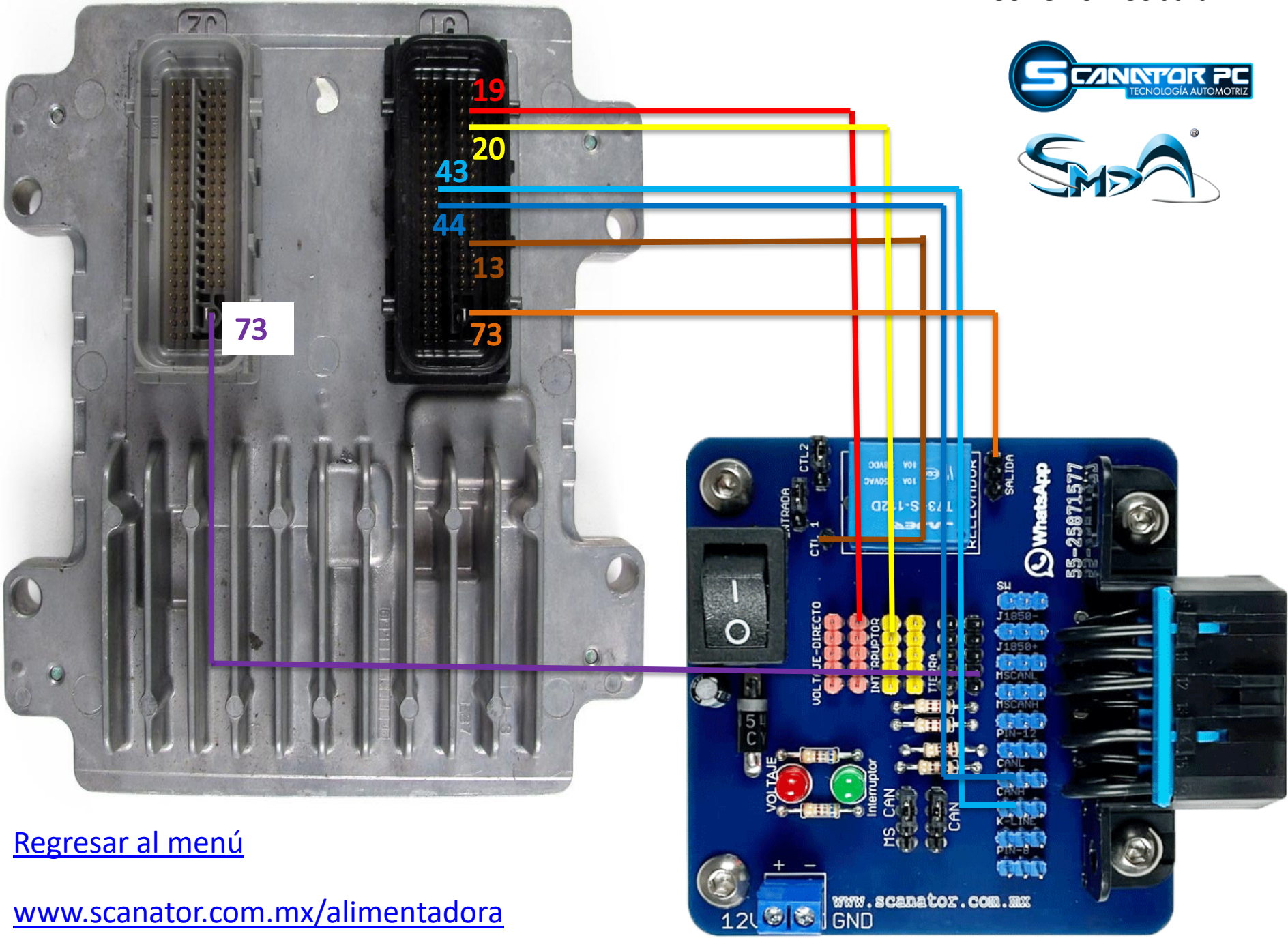

[Regresar al menú](#)

www.scanator.com.mx/alimentadora

Conexión
Captive Sport 2011
y 2012

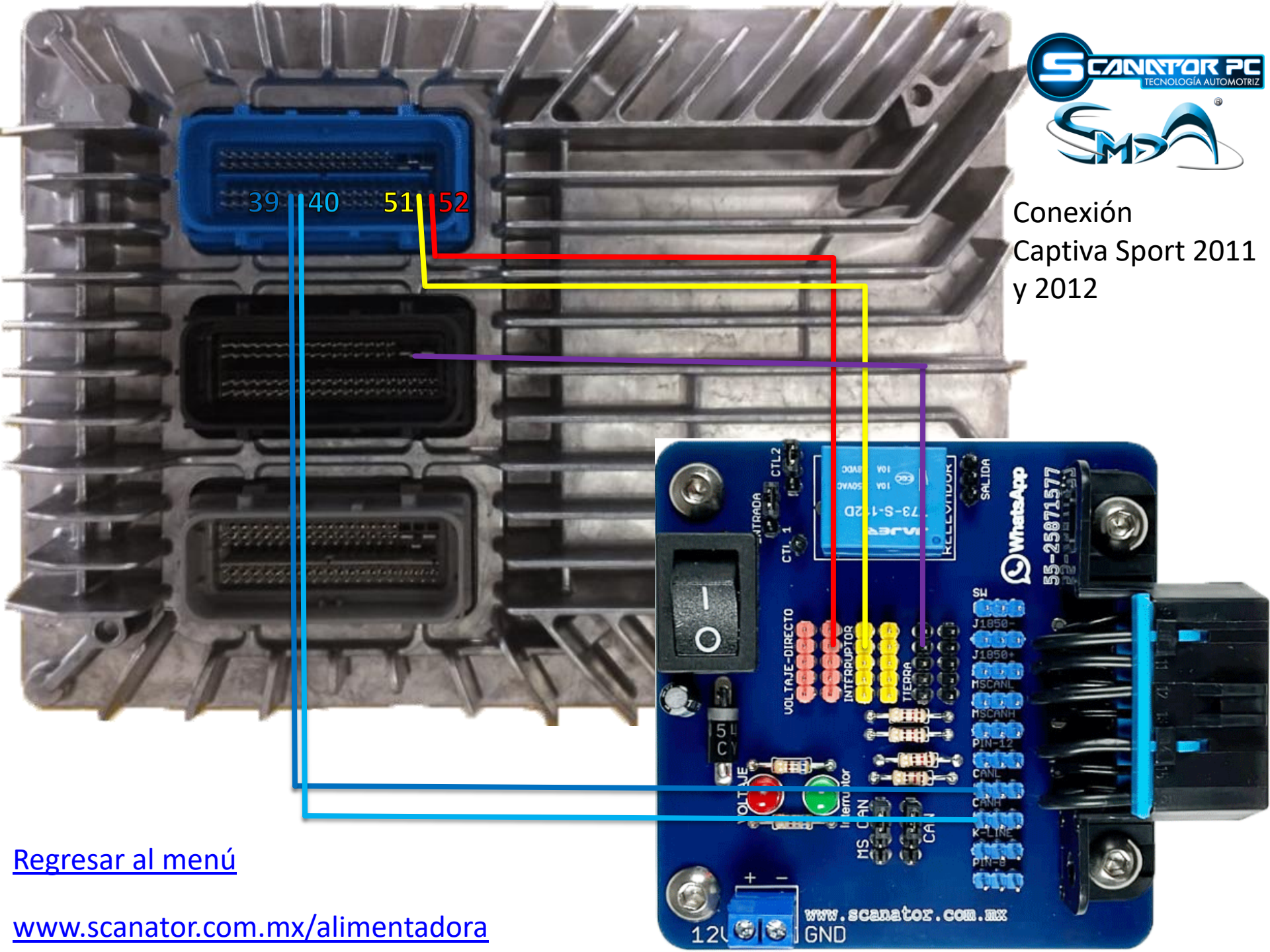

[Regresar al menú](#)

www.scanator.com.mx/alimentadora

Conexión Equinox 2005 3.4

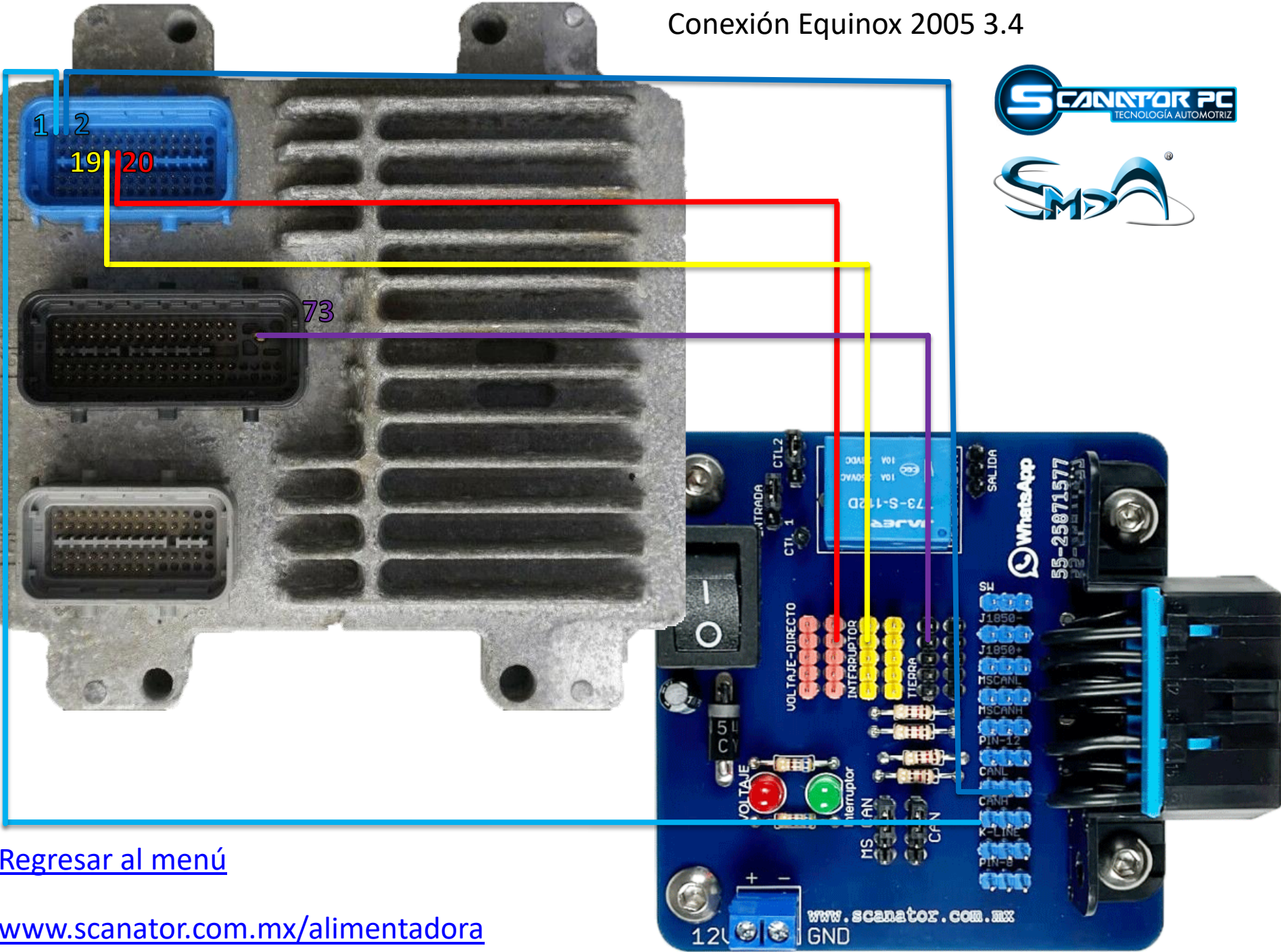

[Regresar al menú](#)

www.scanator.com.mx/alimentadora

12V + - www.scanator.com.mx GND

Conexión Tornado 1.8 2012-2015

Sonic 1.6 2012-2016

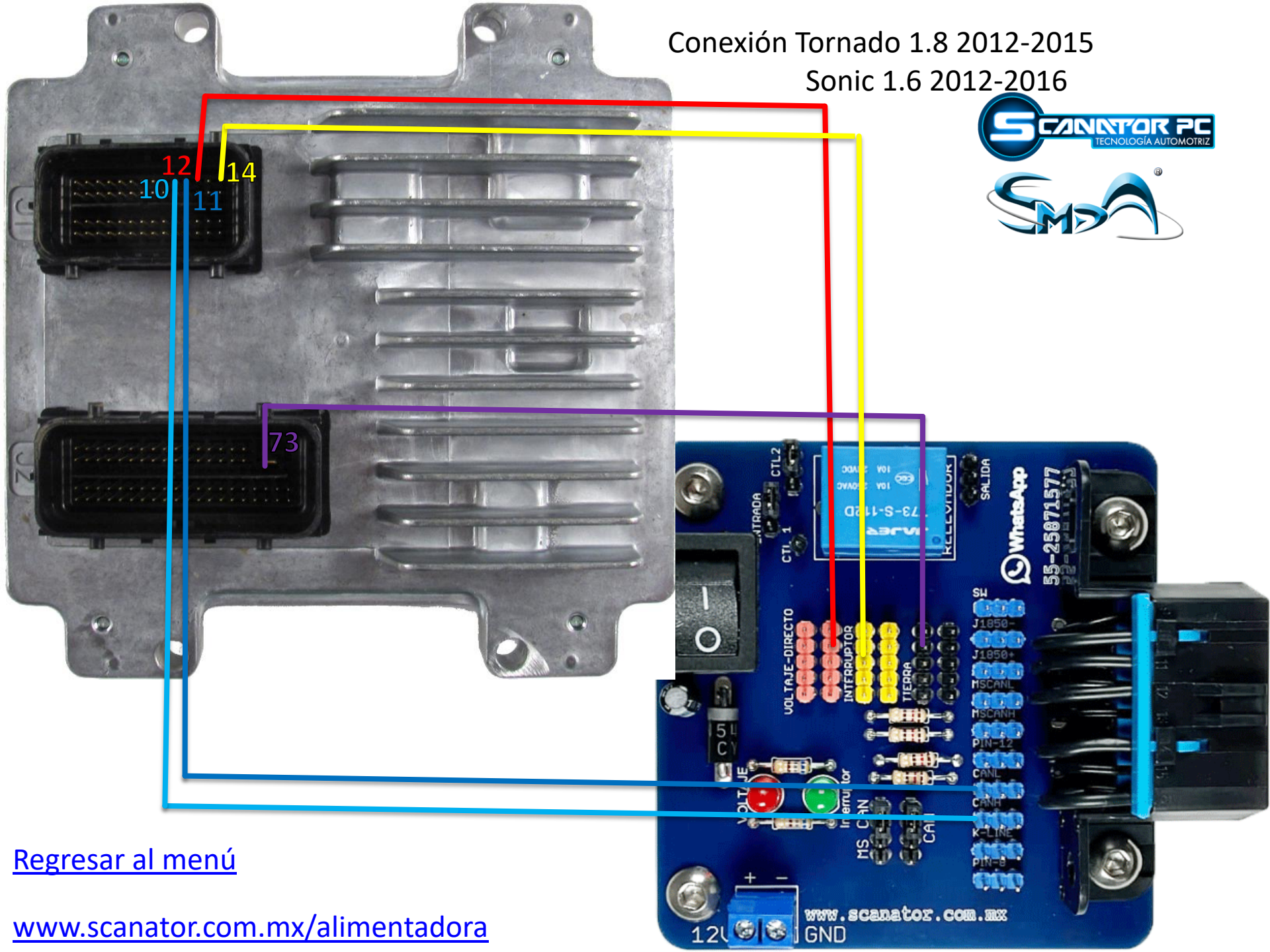

[Regresar al menú](#)

www.scanator.com.mx/alimentadora

Conexión Malibu 2009

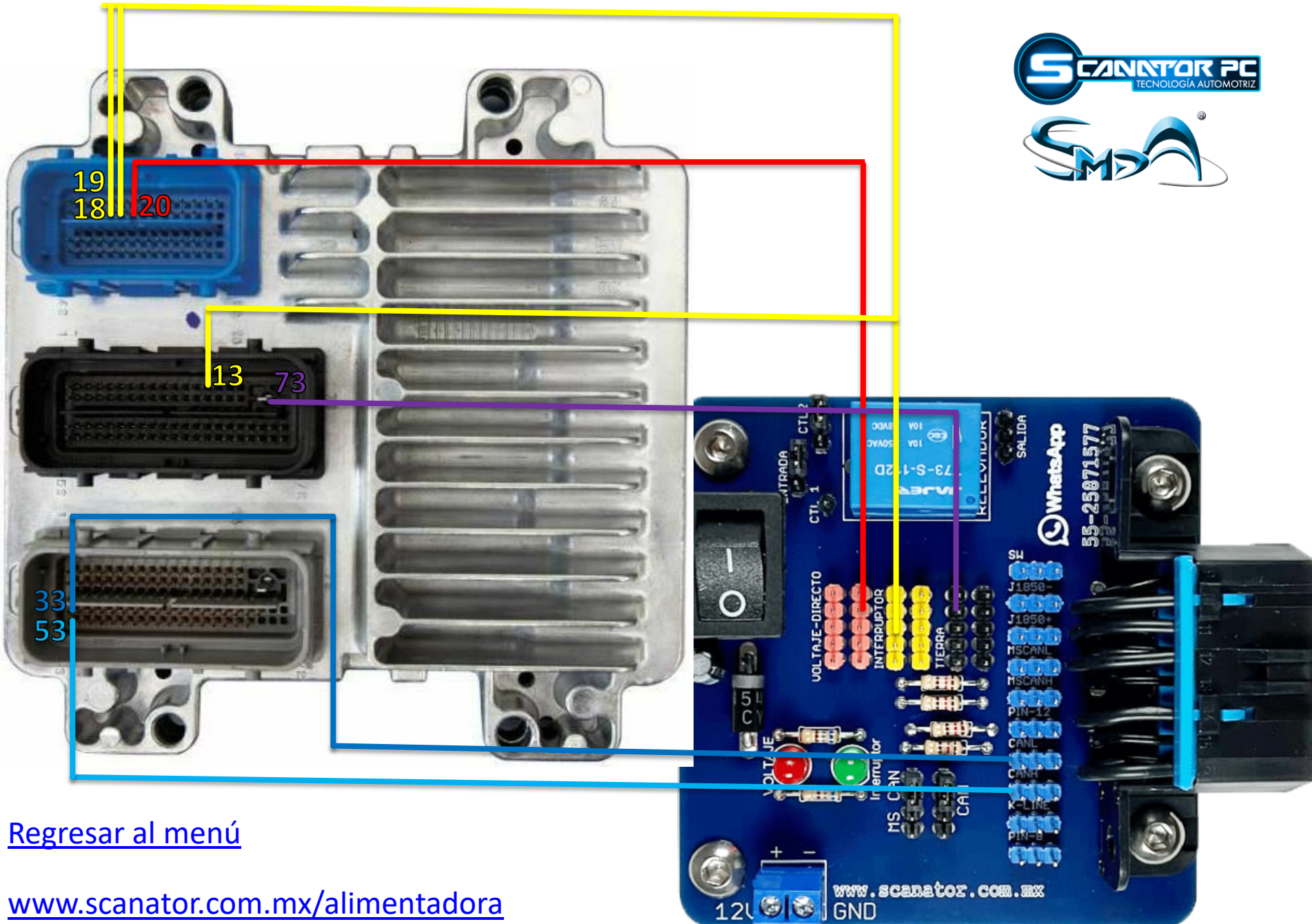

[Regresar al menú](#)

www.scanator.com.mx/alimentadora

12V GND www.scanator.com.mx

Conexión Captiva Sport, Cobalt, Silverado 2008

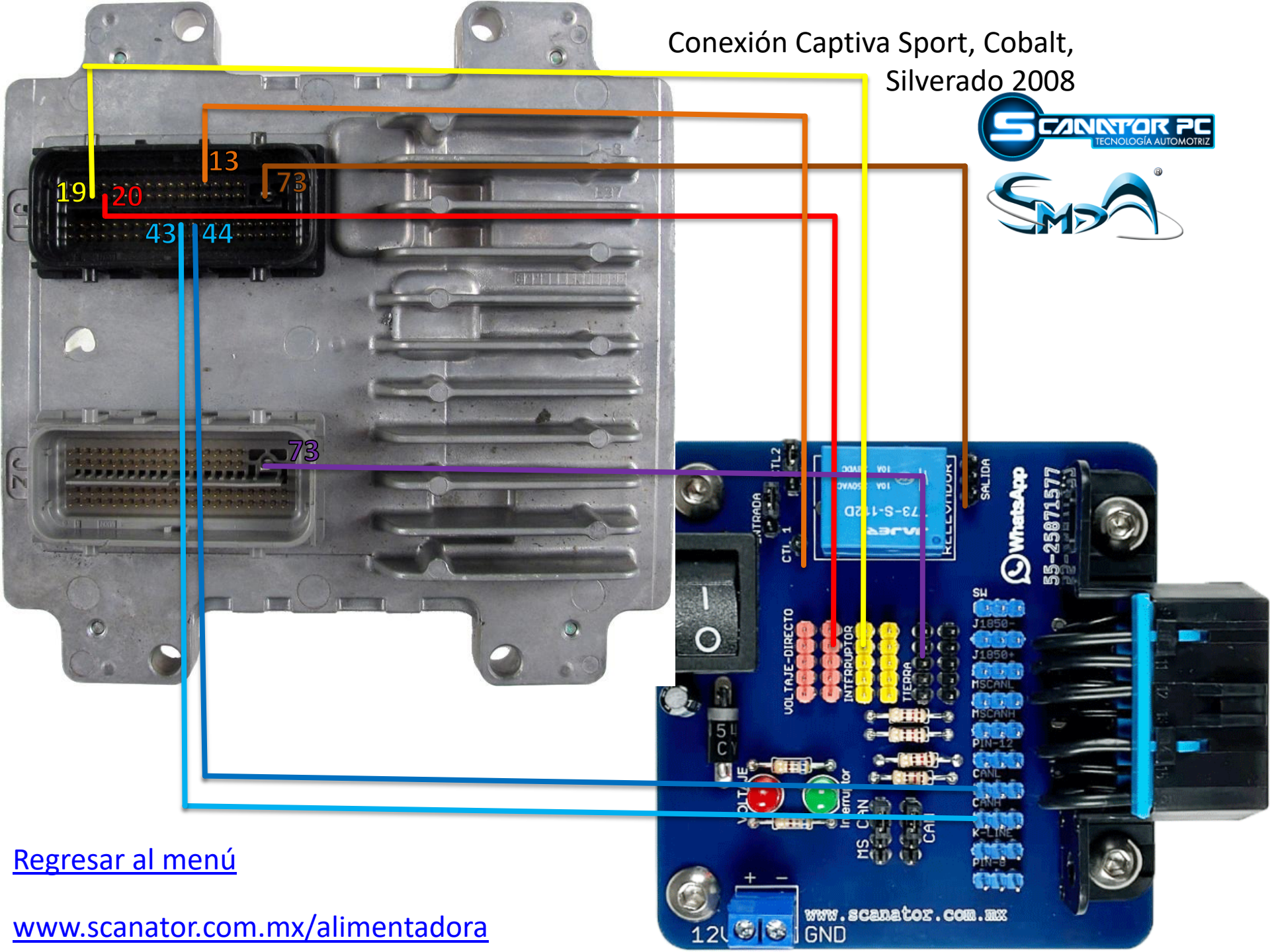

[Regresar al menú](#)

www.scanator.com.mx/alimentadora

Conexión Cavalier 2005 2.2

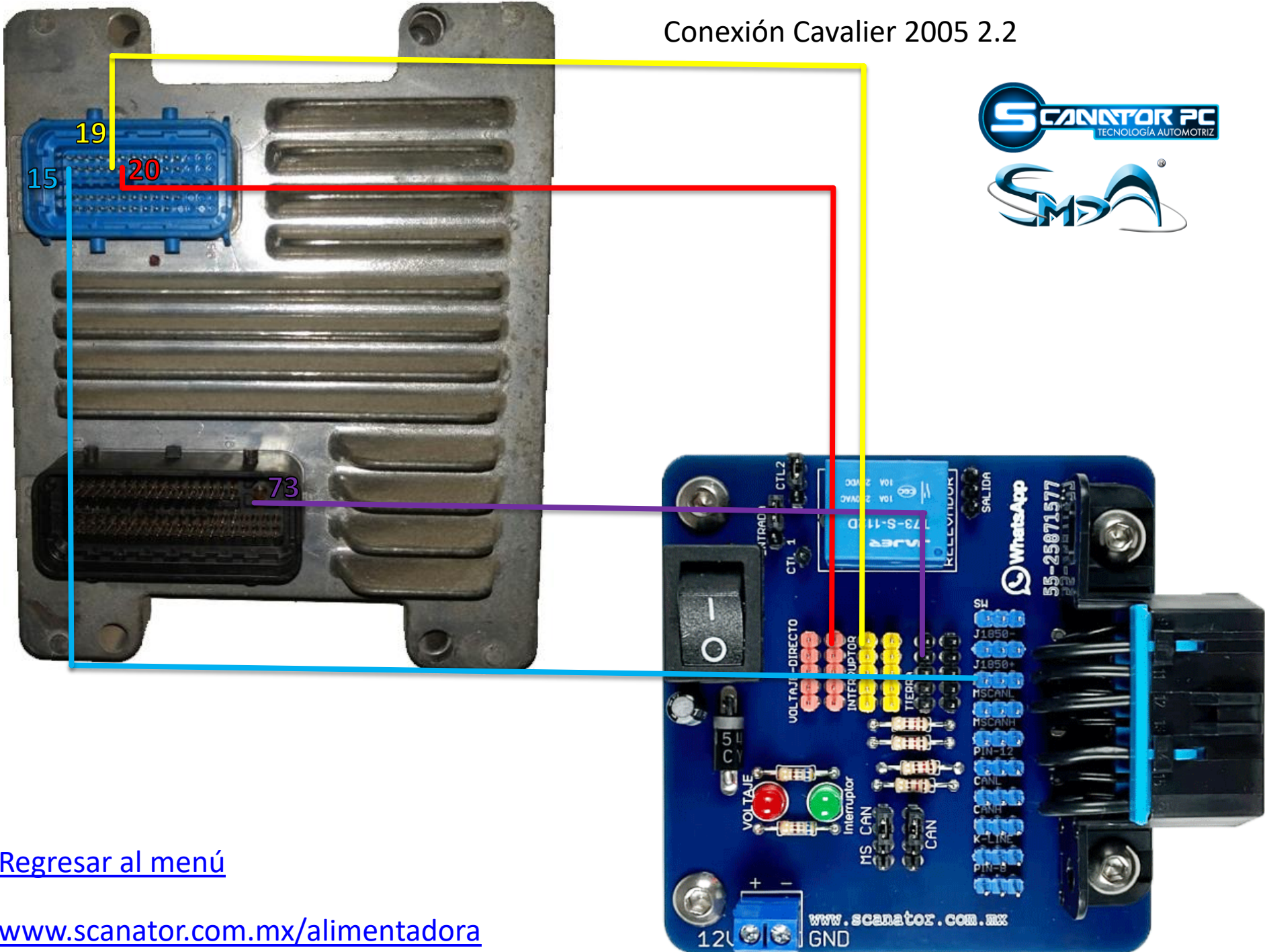

[Regresar al menú](#)

www.scanator.com.mx/alimentadora

Conexión Optra y AVEO

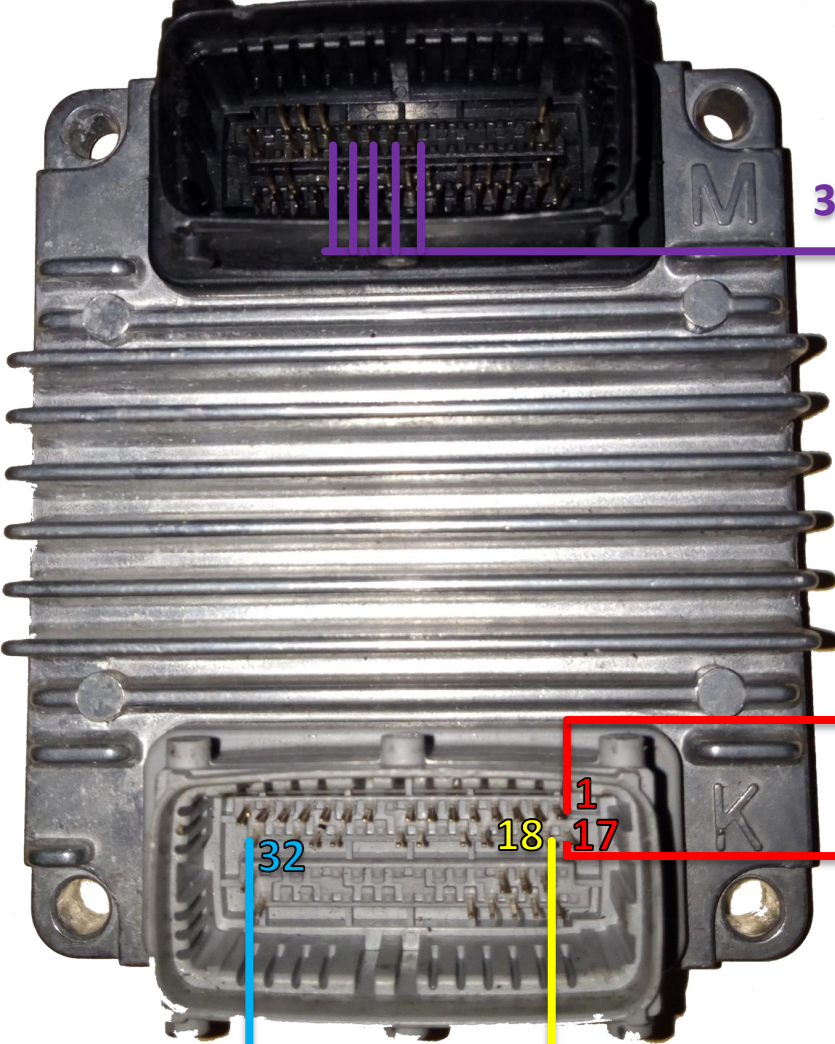

37, 38, 39, 40 y 41

1
17
18

32

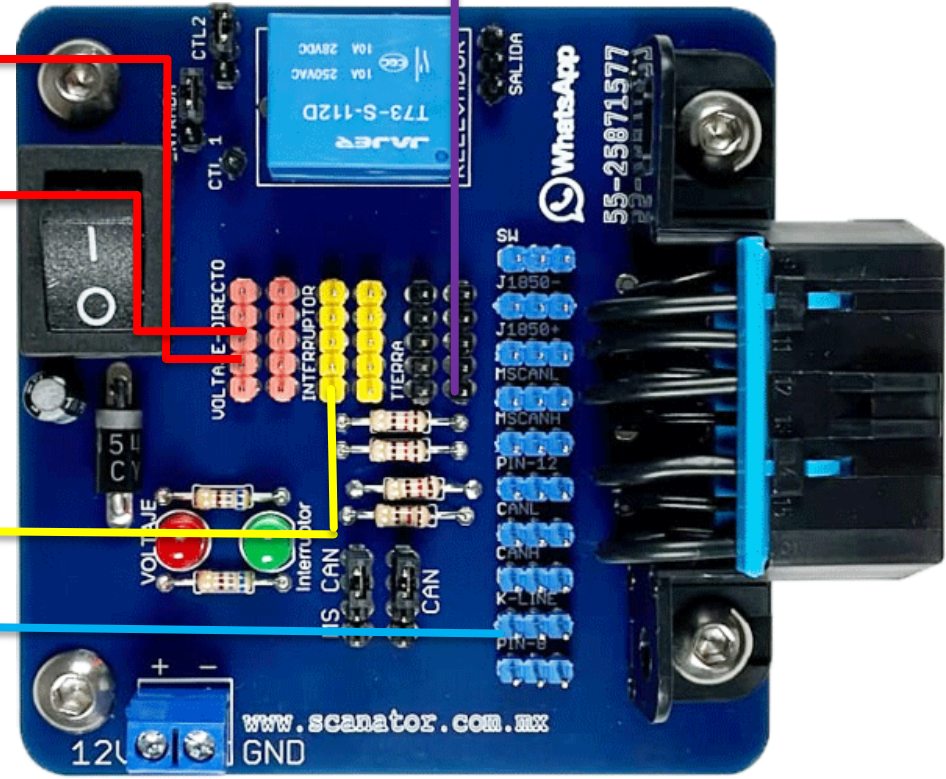

[Regresar al menú](#)

www.scanator.com.mx/alimentadora

Conexión Optra y AVEO

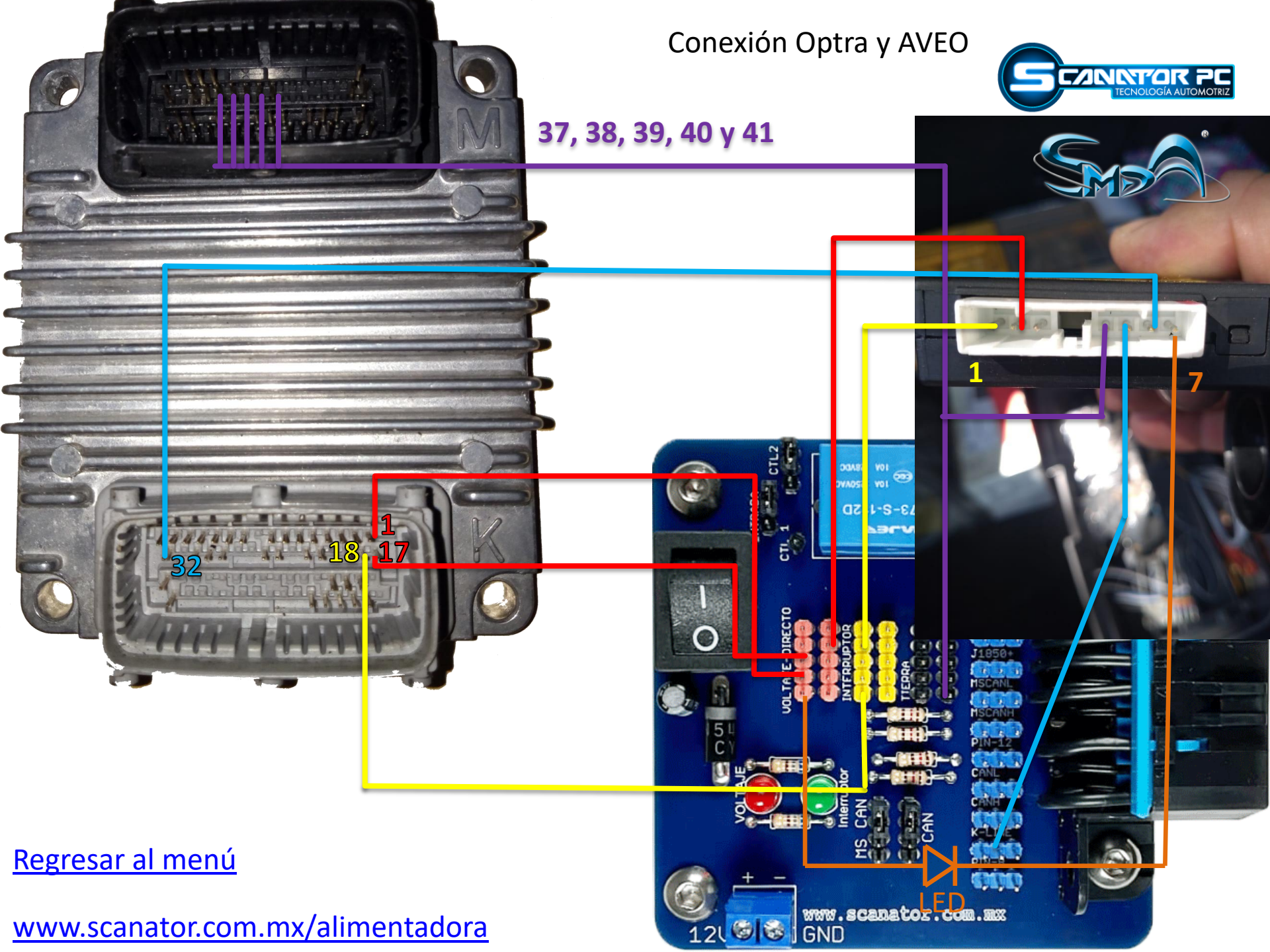

37, 38, 39, 40 y 41

1
17
18
32

1

7

[Regresar al menú](#)

www.scanator.com.mx/alimentadora

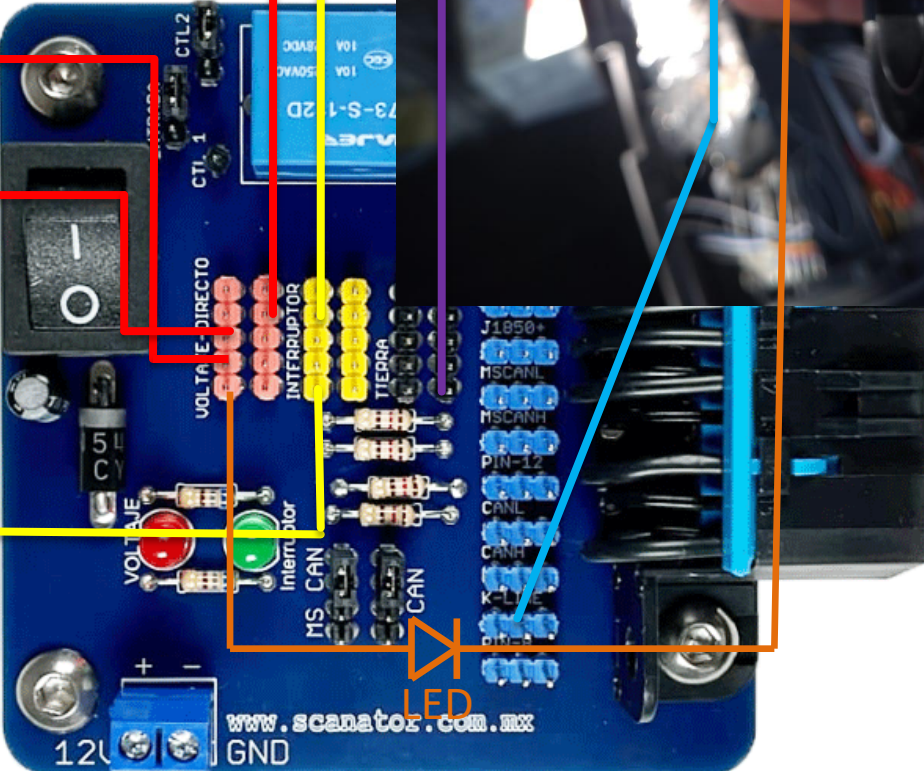

Conexión Uplander 2006 3.5L

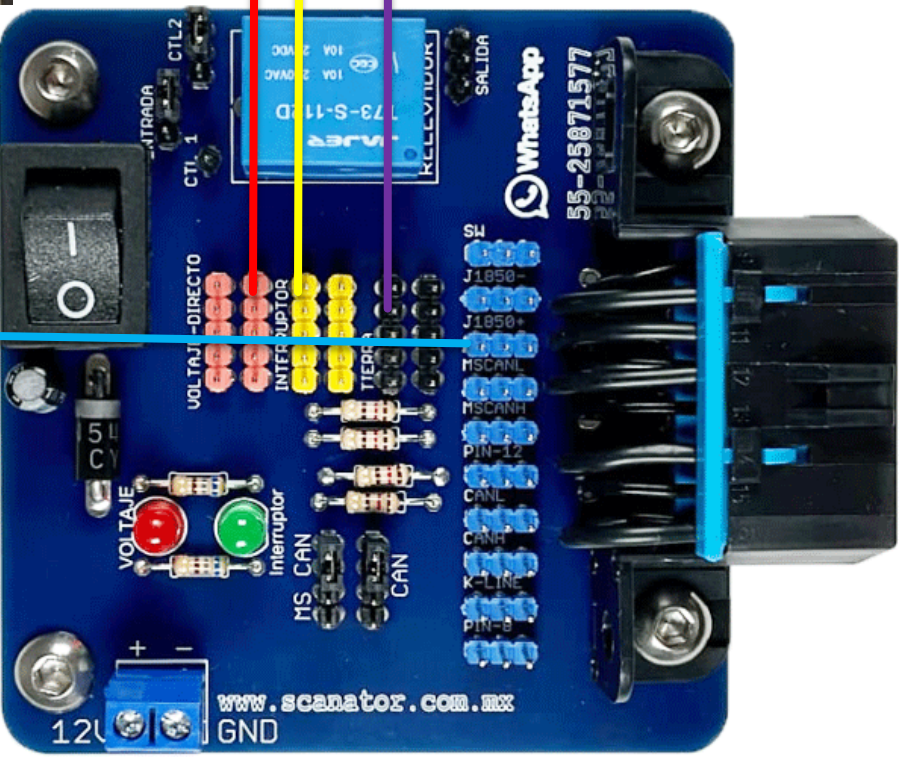
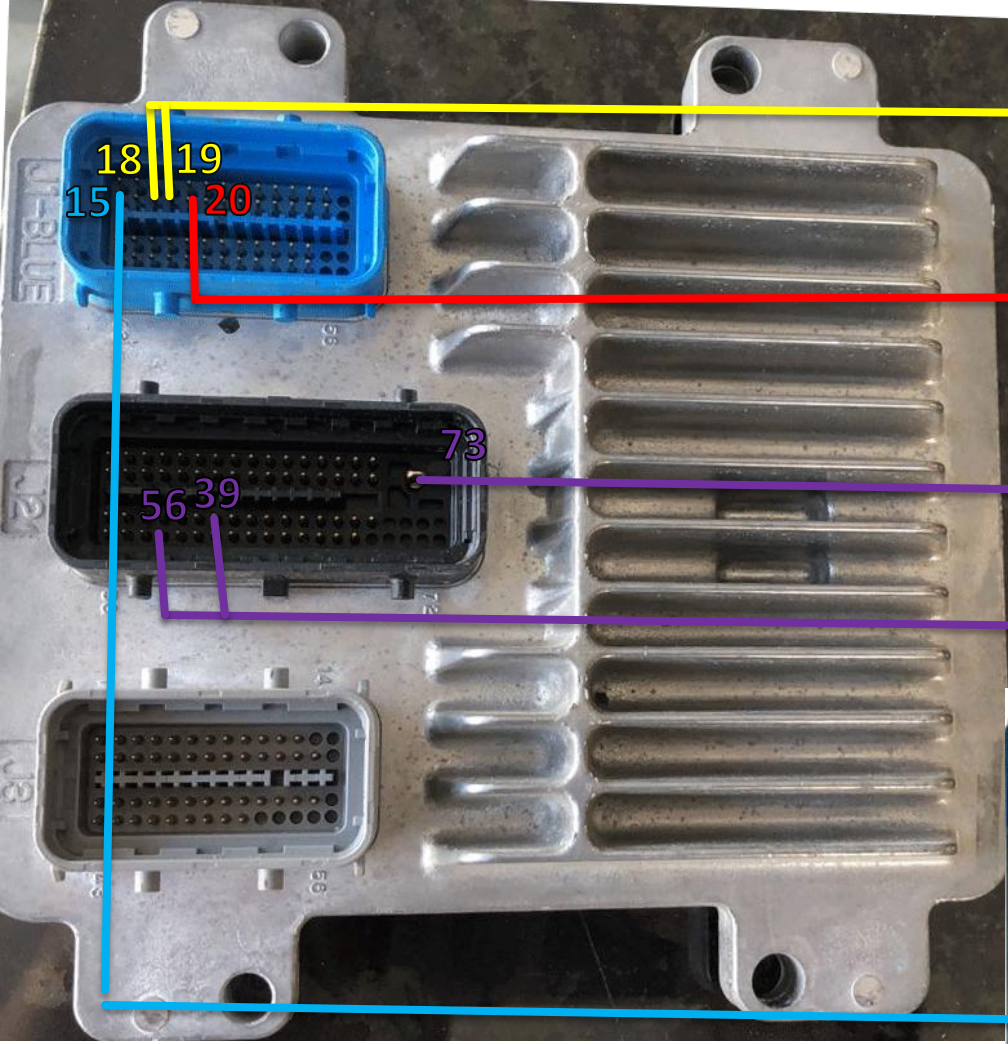

[Regresar al menú](#)

www.scanator.com.mx/alimentadora

Conexión: SBECIII 80 pines (Caraban 2002)

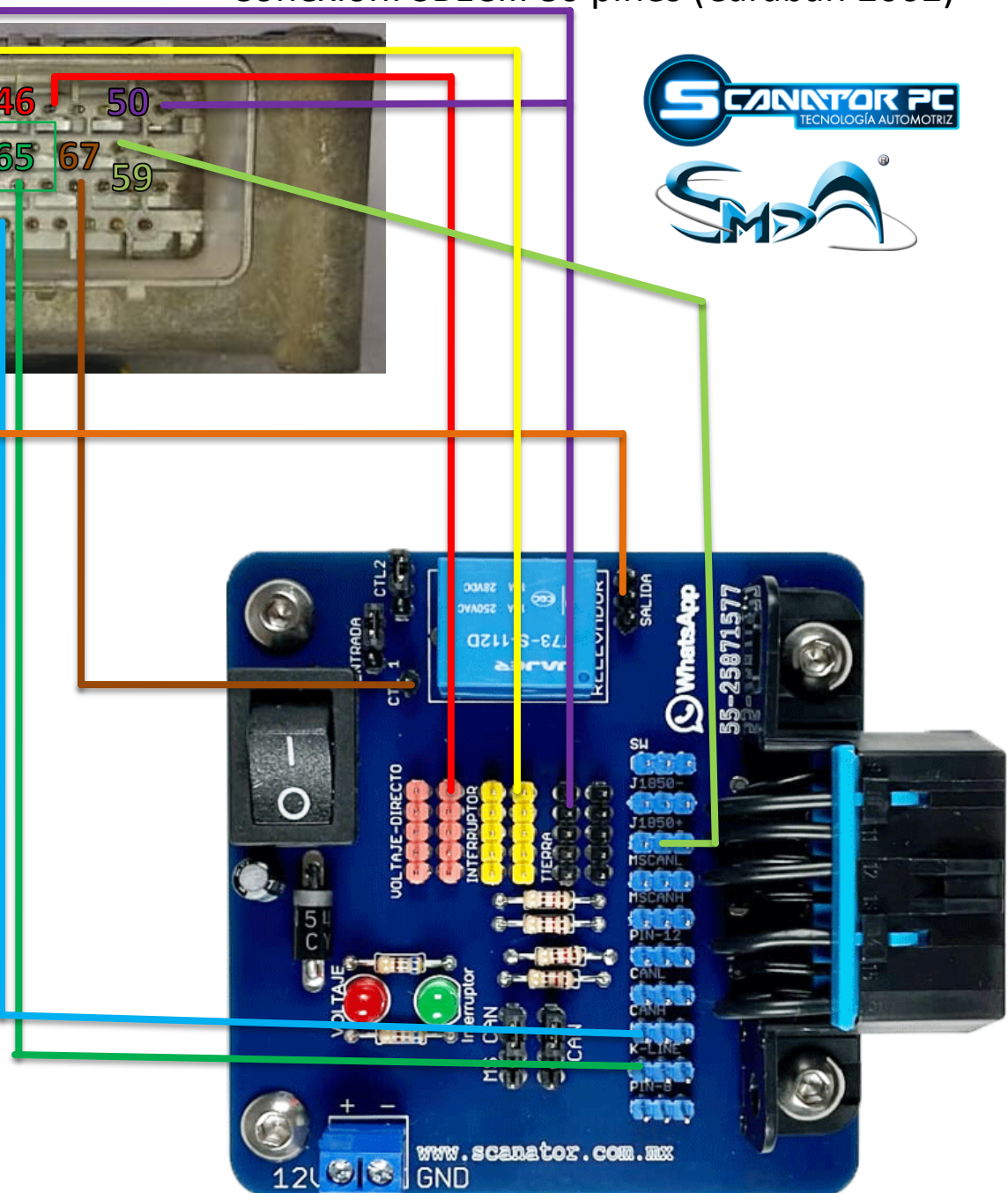
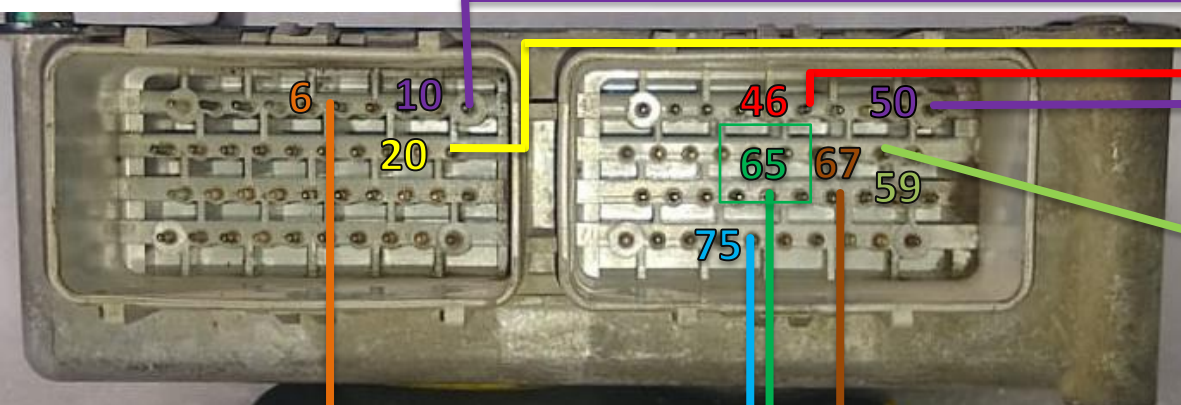

[Regresar al menú](#)

www.scanator.com.mx/alimentadora

Ford TCM DPS6
Ecosport 2013+
Fiesta 2011+
Figo 2016+
Focus 2012+

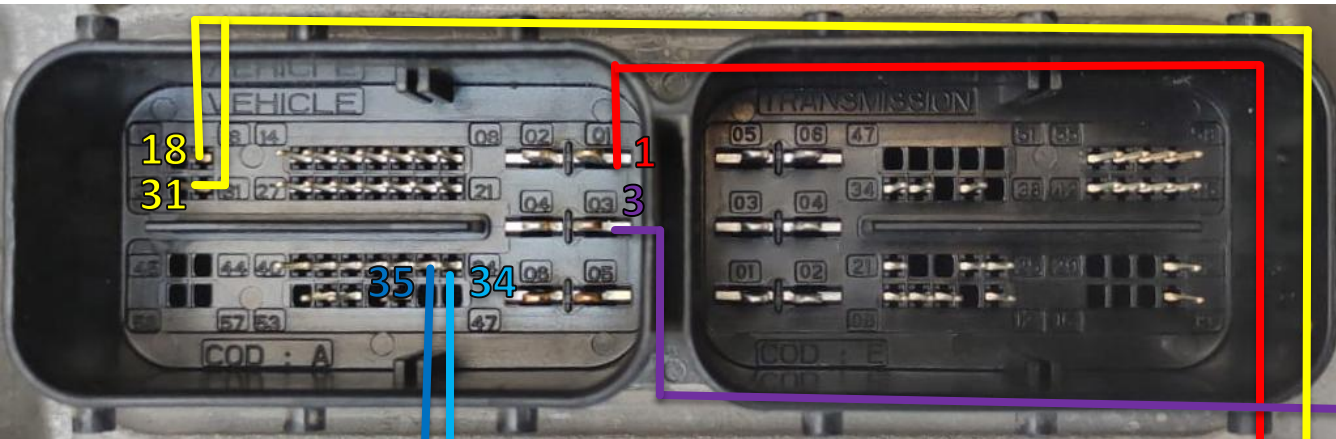

Colocación de jumpers

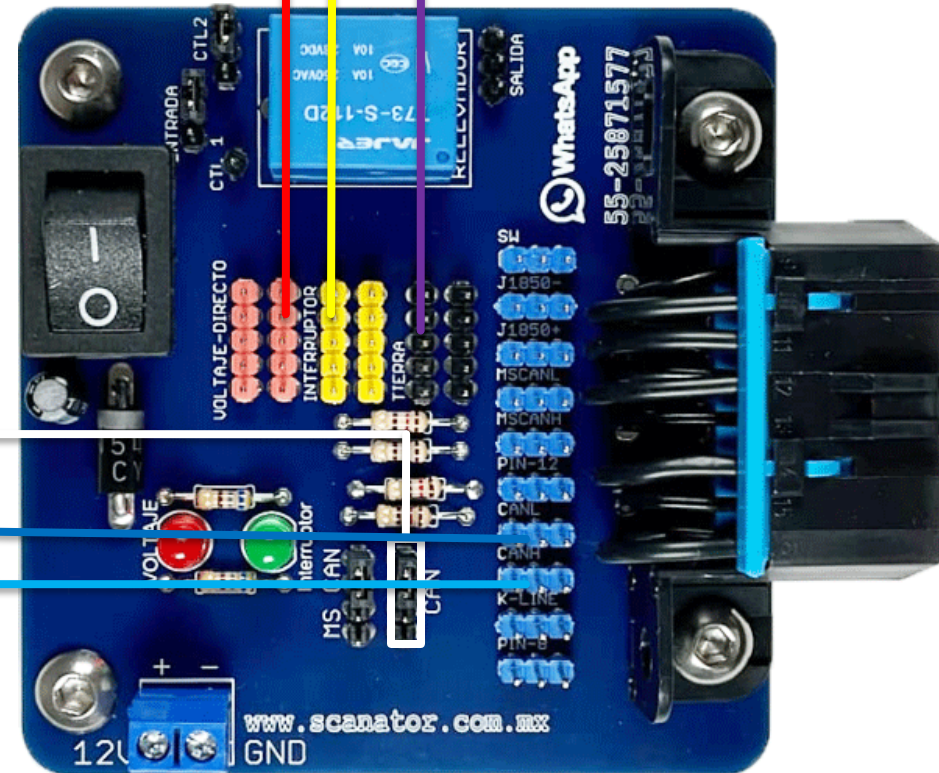

[Regresar al menú](#)

www.scanator.com.mx/alimentadora

Conexión
Honda Civic Coupe
2006-2012 1.8



A

B

C

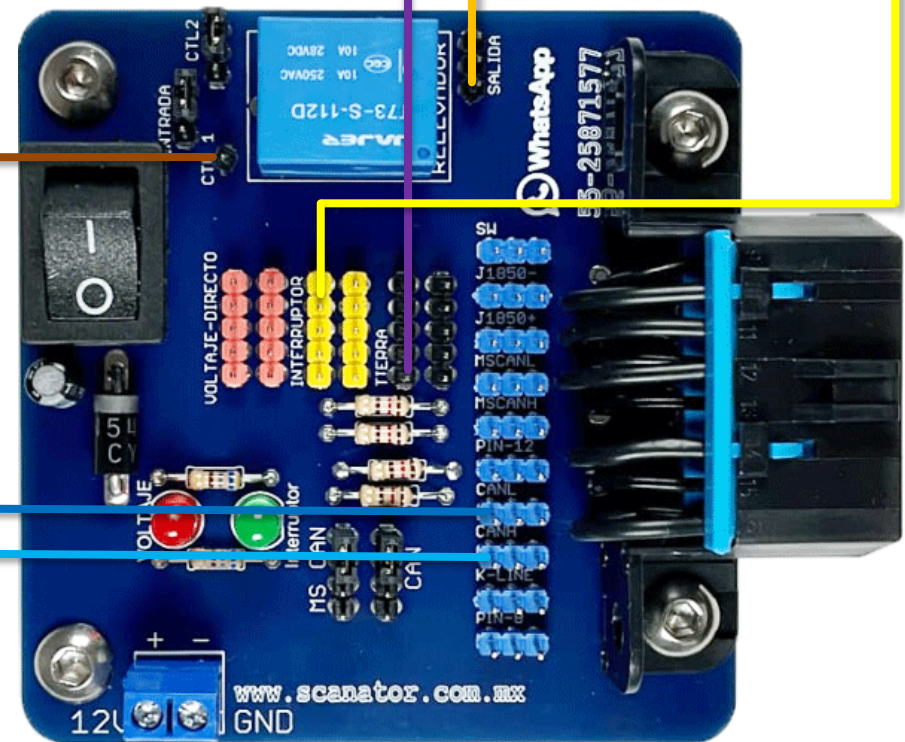
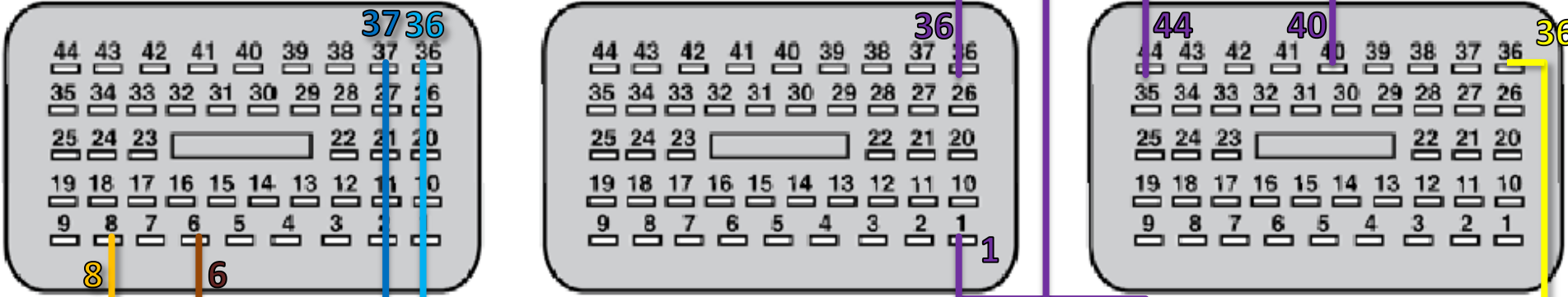

[Regresar al menú](#)

www.scanator.com.mx/alimentadora



GPEC 2

Chrysler

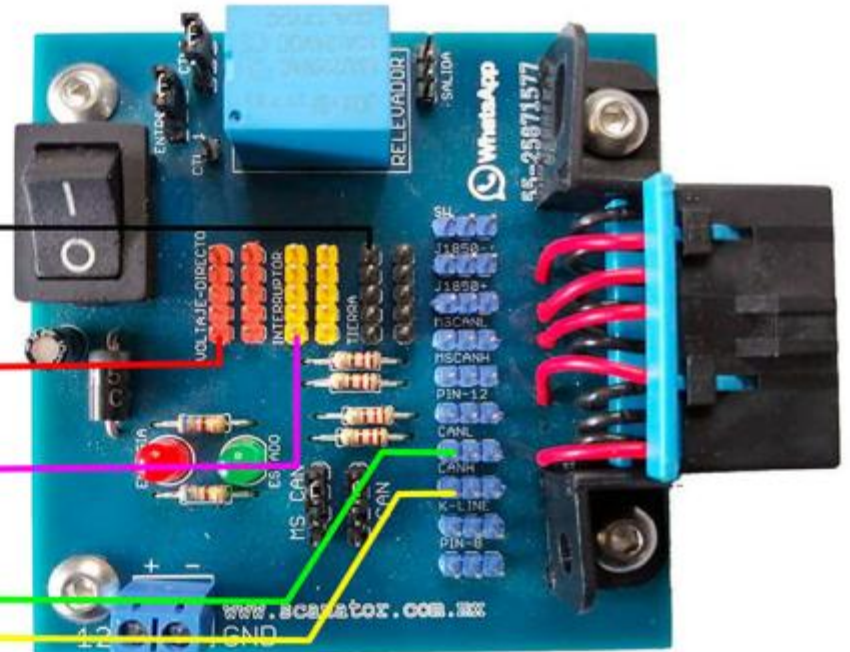
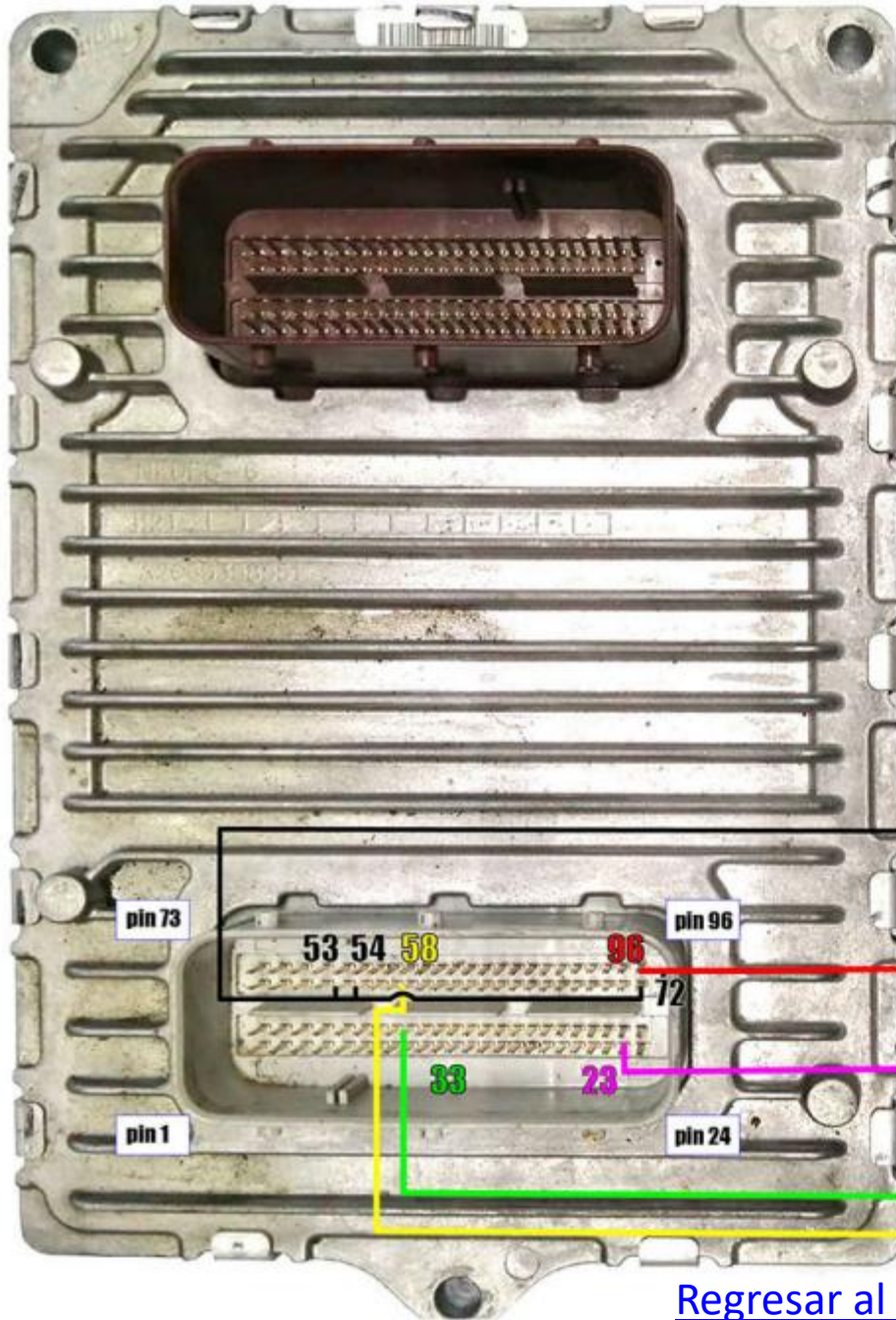

[Regresar al menú](#)

Beetle/Jetta
clásico 80 pines

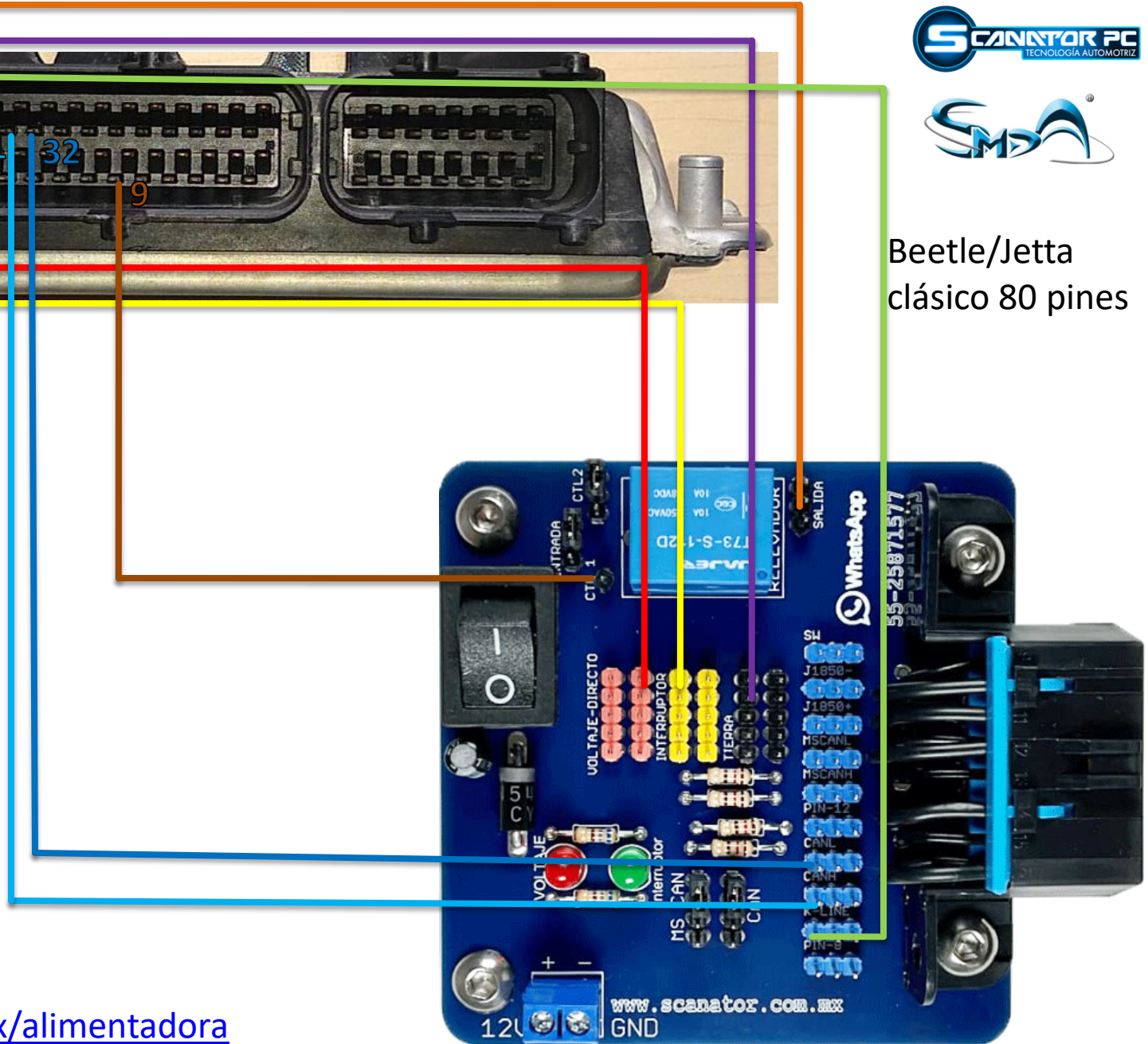
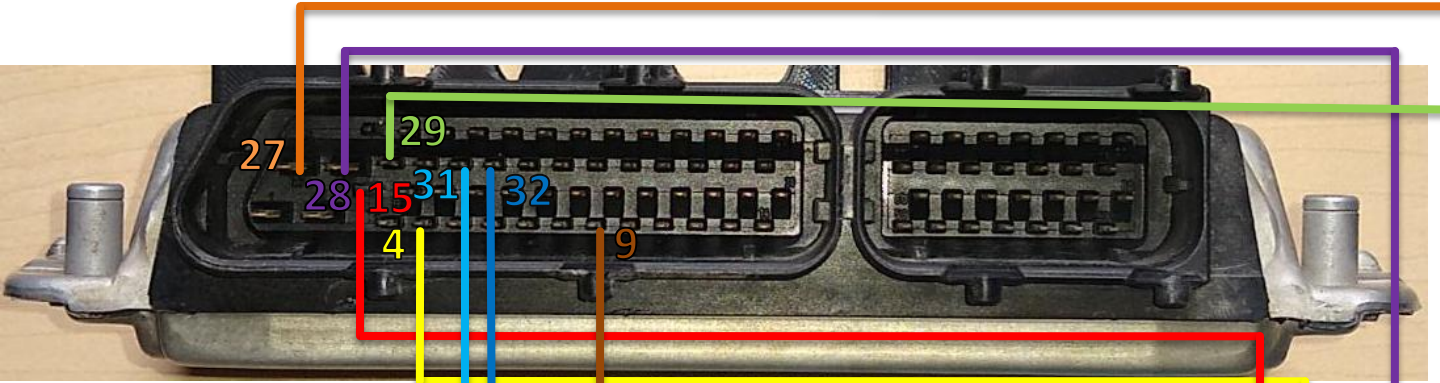

[Regresar al menú](#)

www.scanator.com.mx/alimentadora

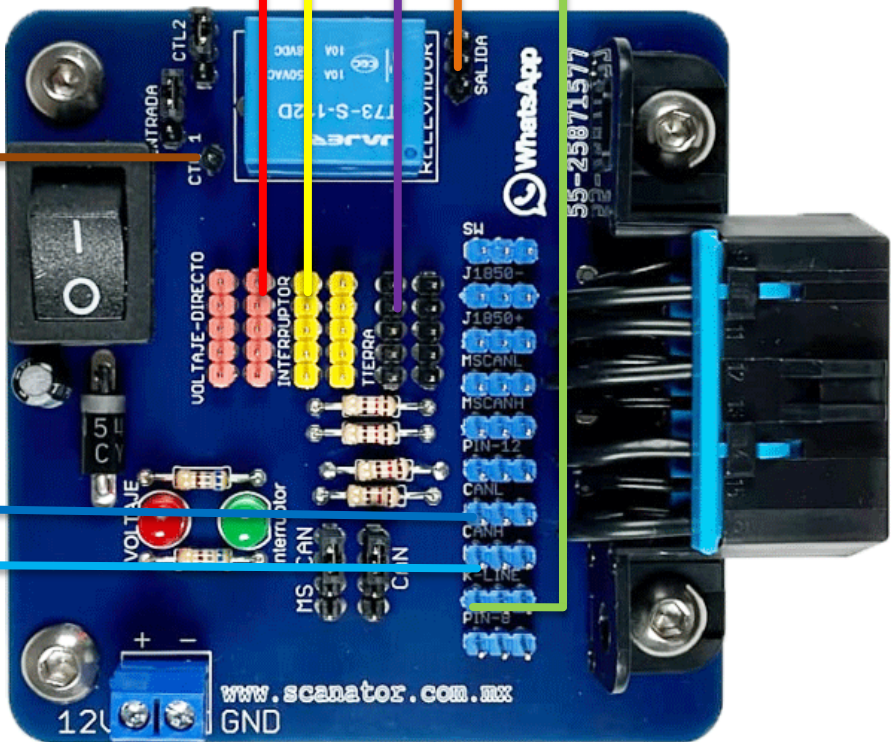

Conexión TrailBlazer 2006, motor 4.2L

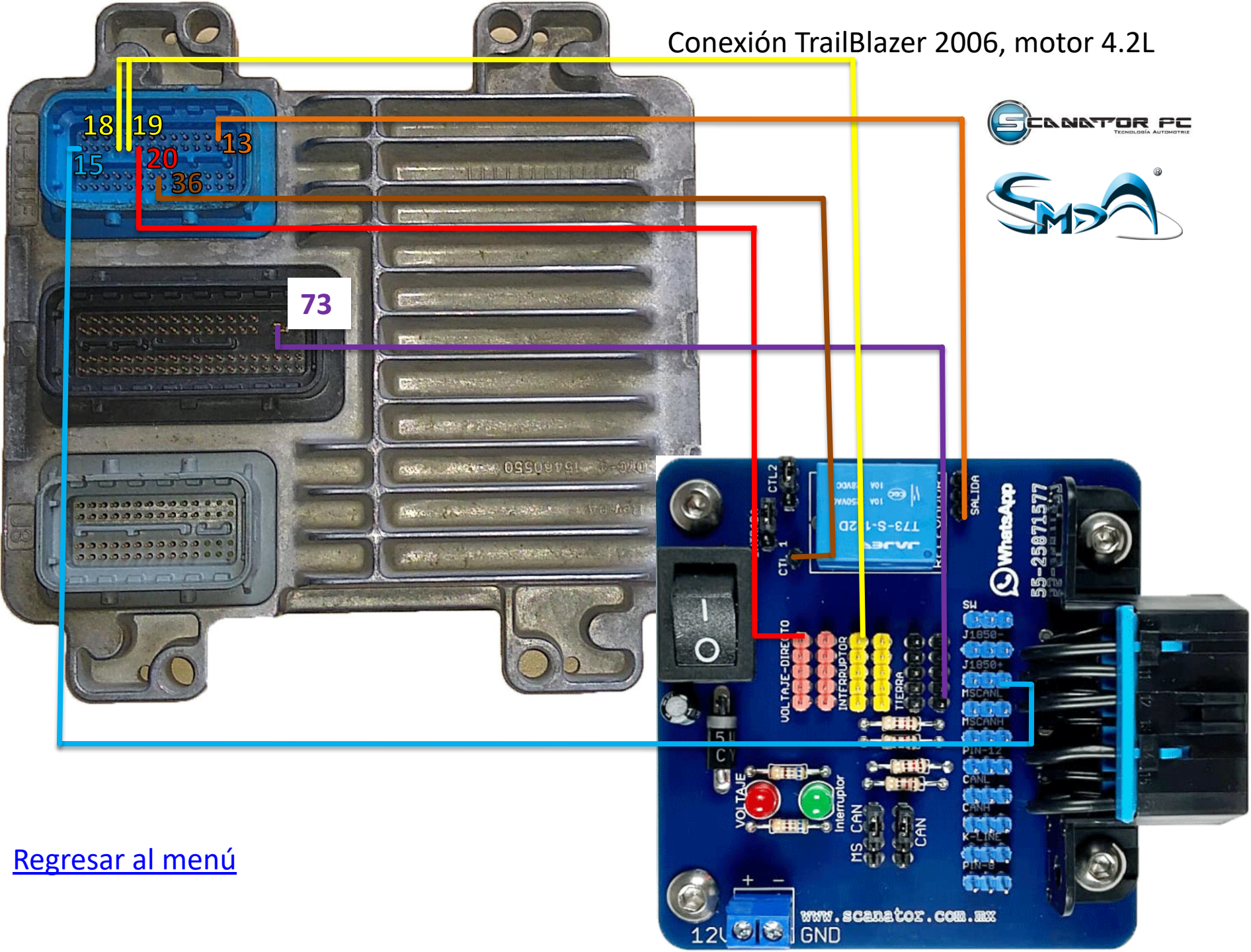

[Regresar al menú](#)

Audi A3 2da generación
(2004-2012)

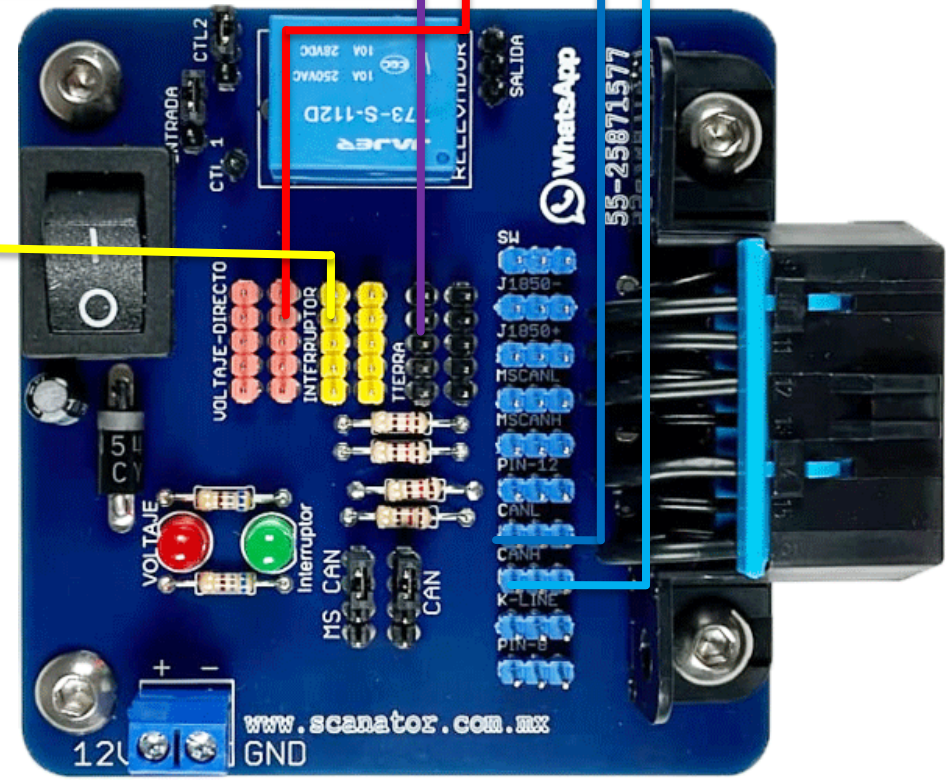
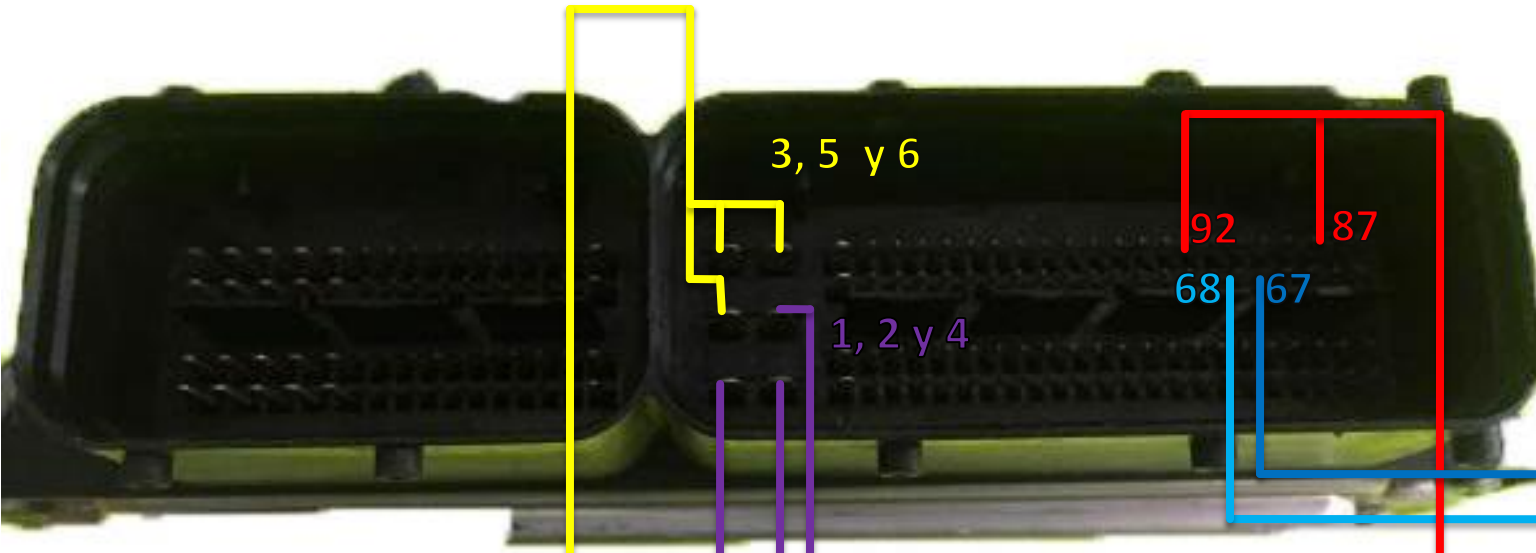

[Regresar al menú](#)

www.scanator.com.mx/alimentadora

Conexión Malibu LS 2005 3.5



1 2
15 19 20

73

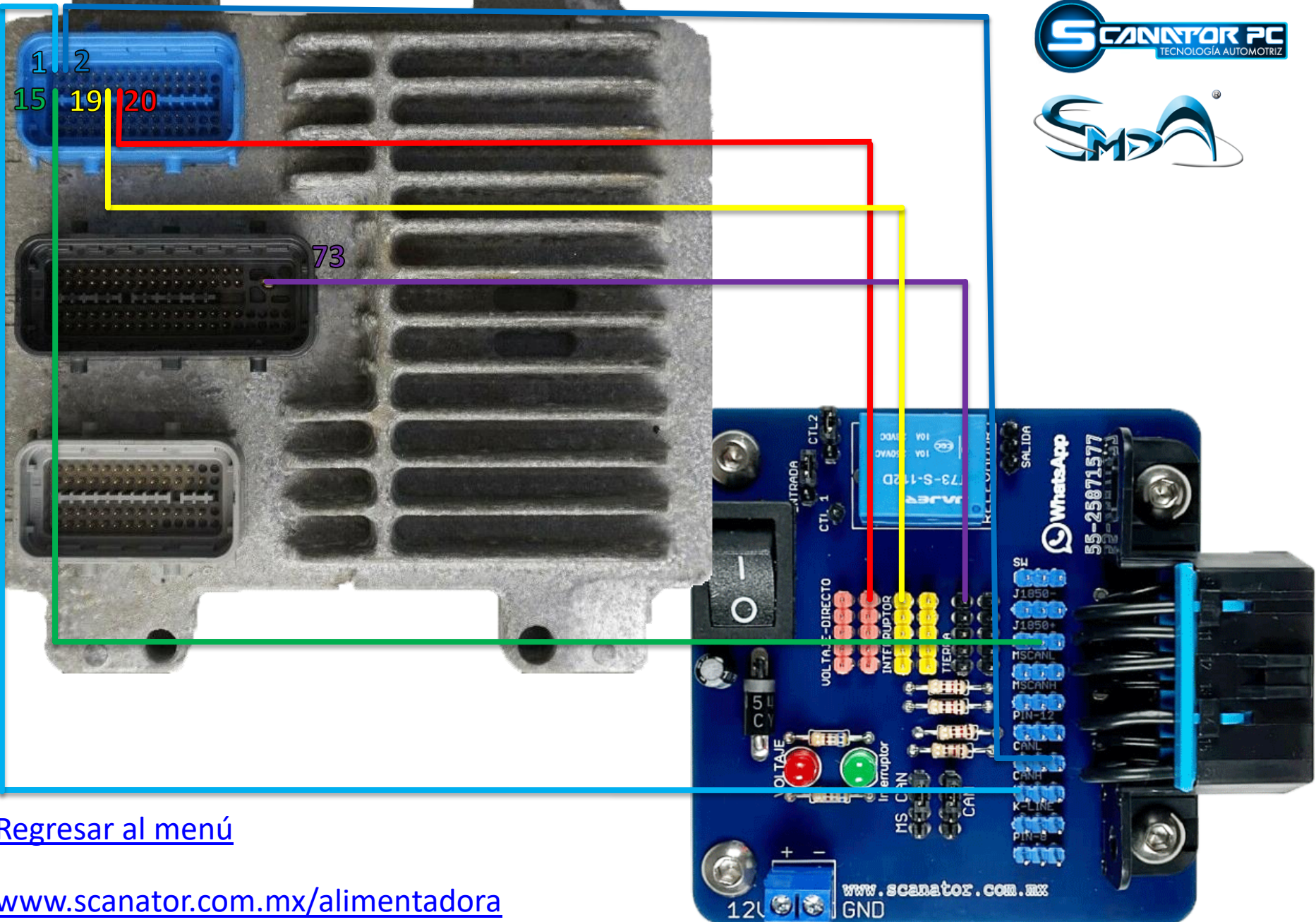

[Regresar al menú](#)

www.scanator.com.mx/alimentadora

12V + -
GND
www.scanator.com.mx

Conexión Trail Blazer 2003

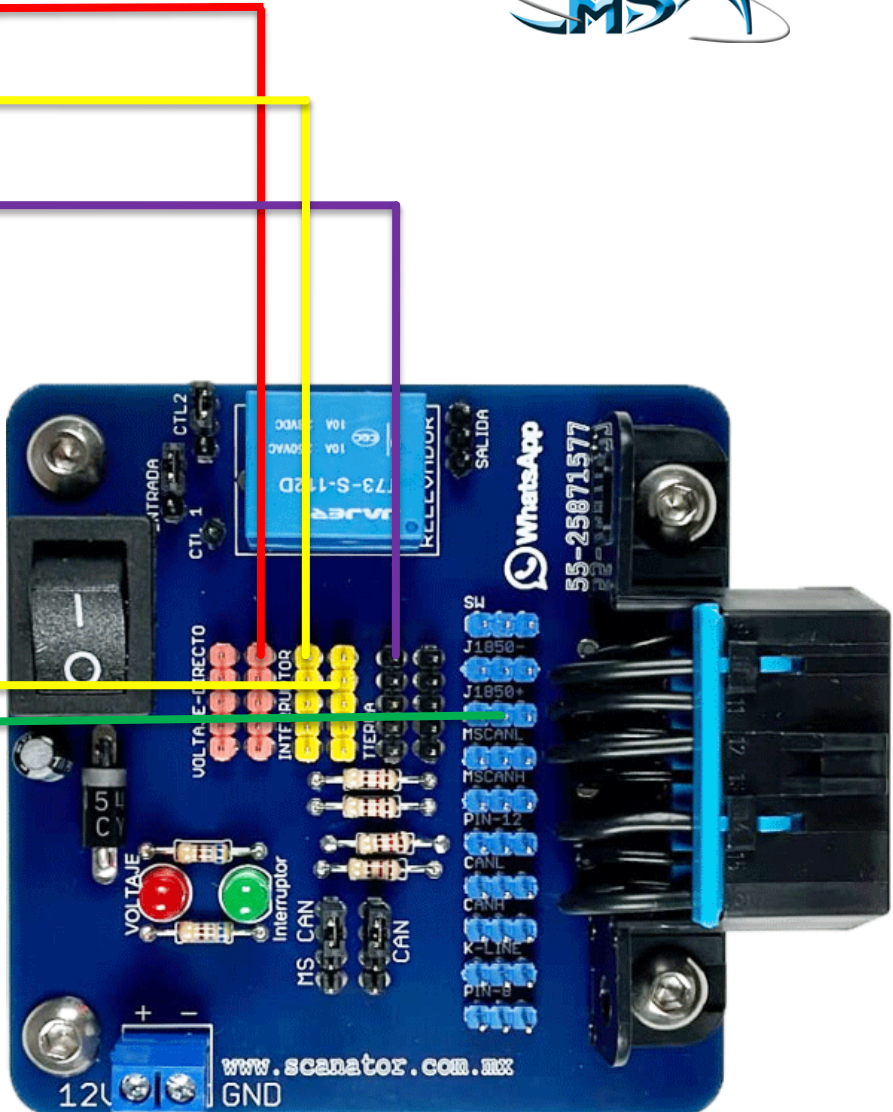
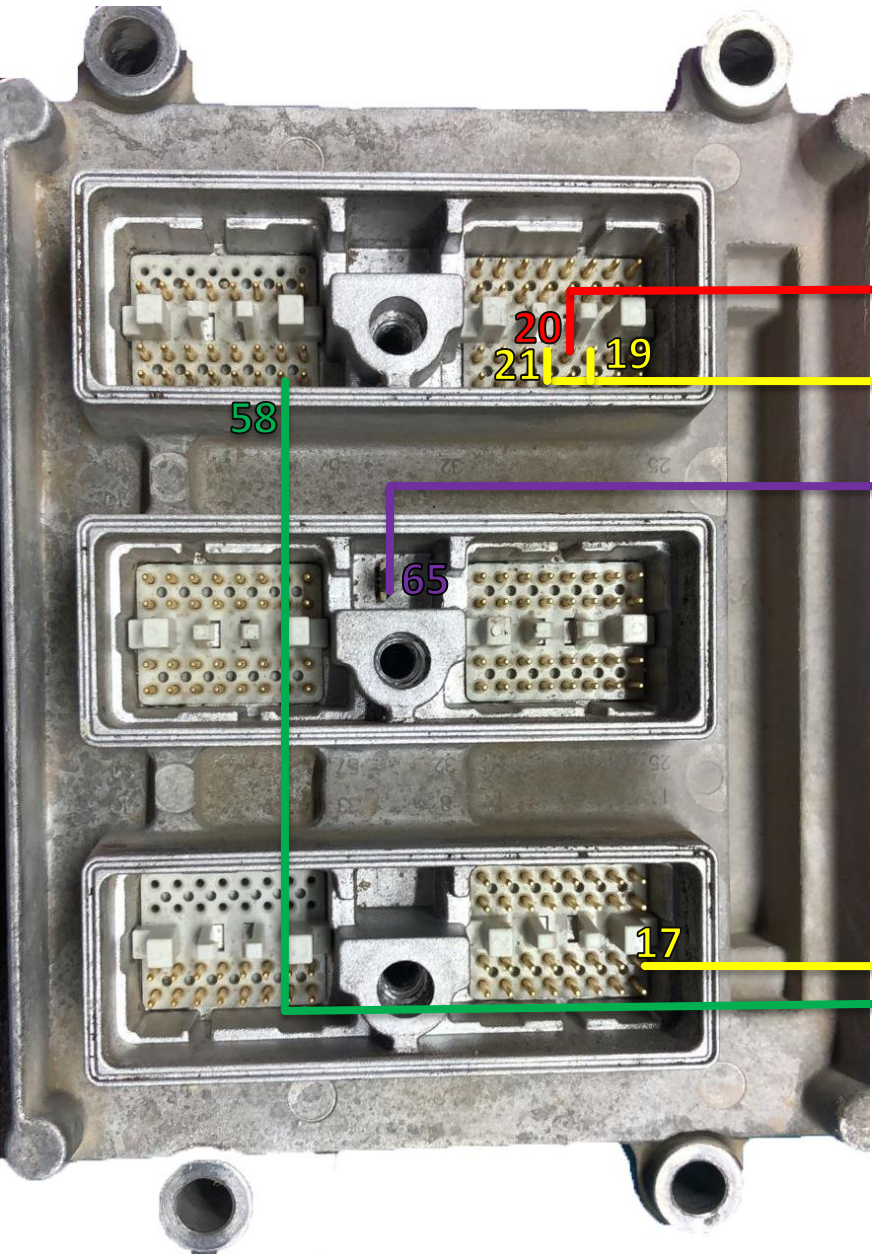

[Regresar al menú](#)

www.scanator.com.mx/alimentadora

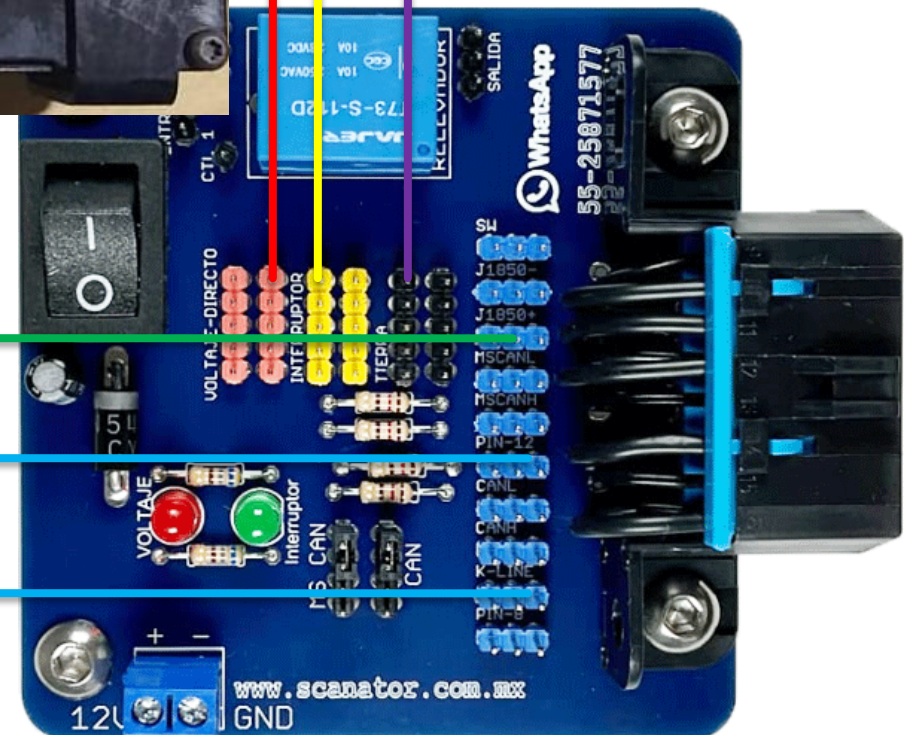
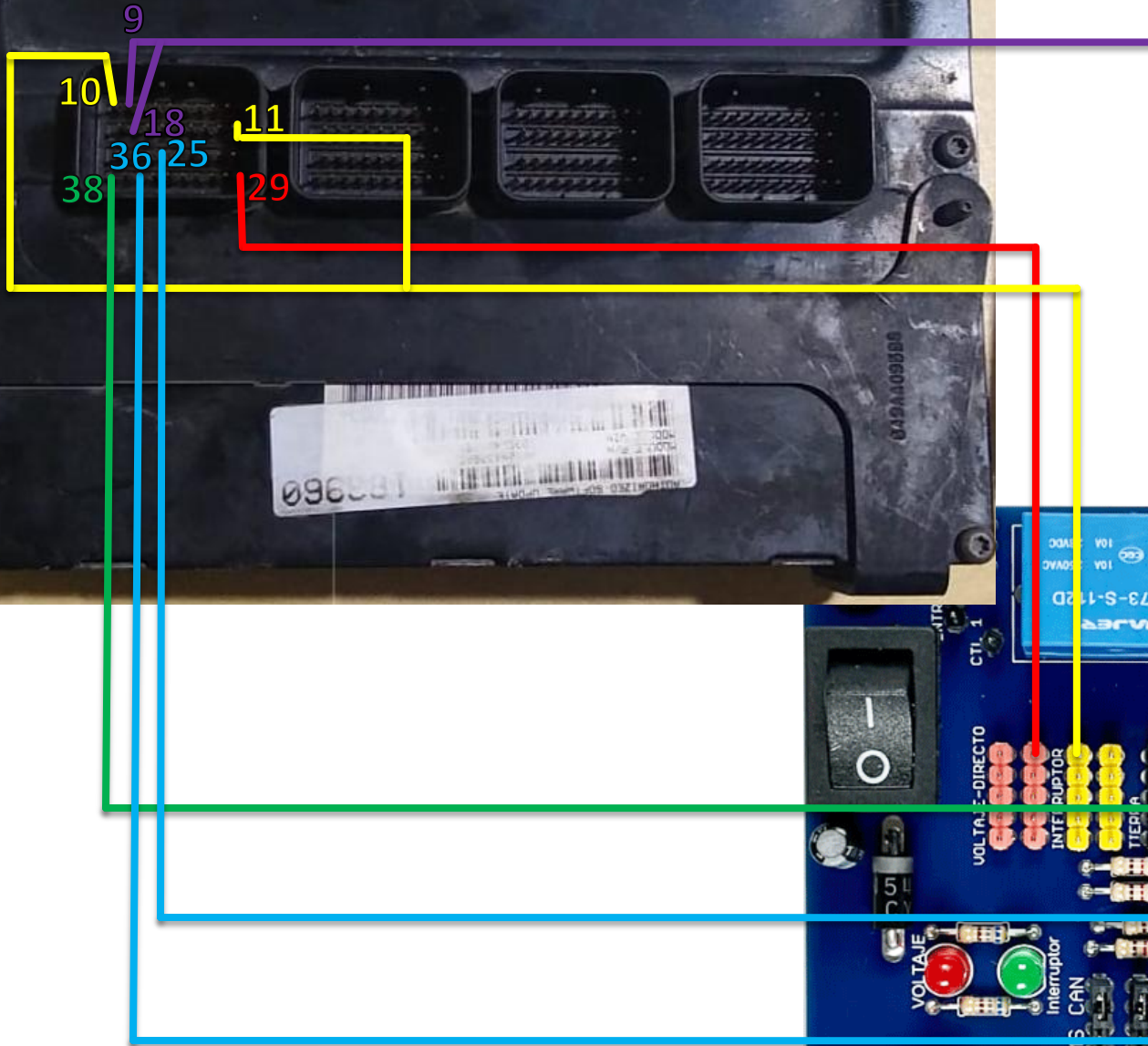

[Regresar al menú](#)

www.scanator.com.mx/alimentadora

Conexión Altima, 2007

2.5

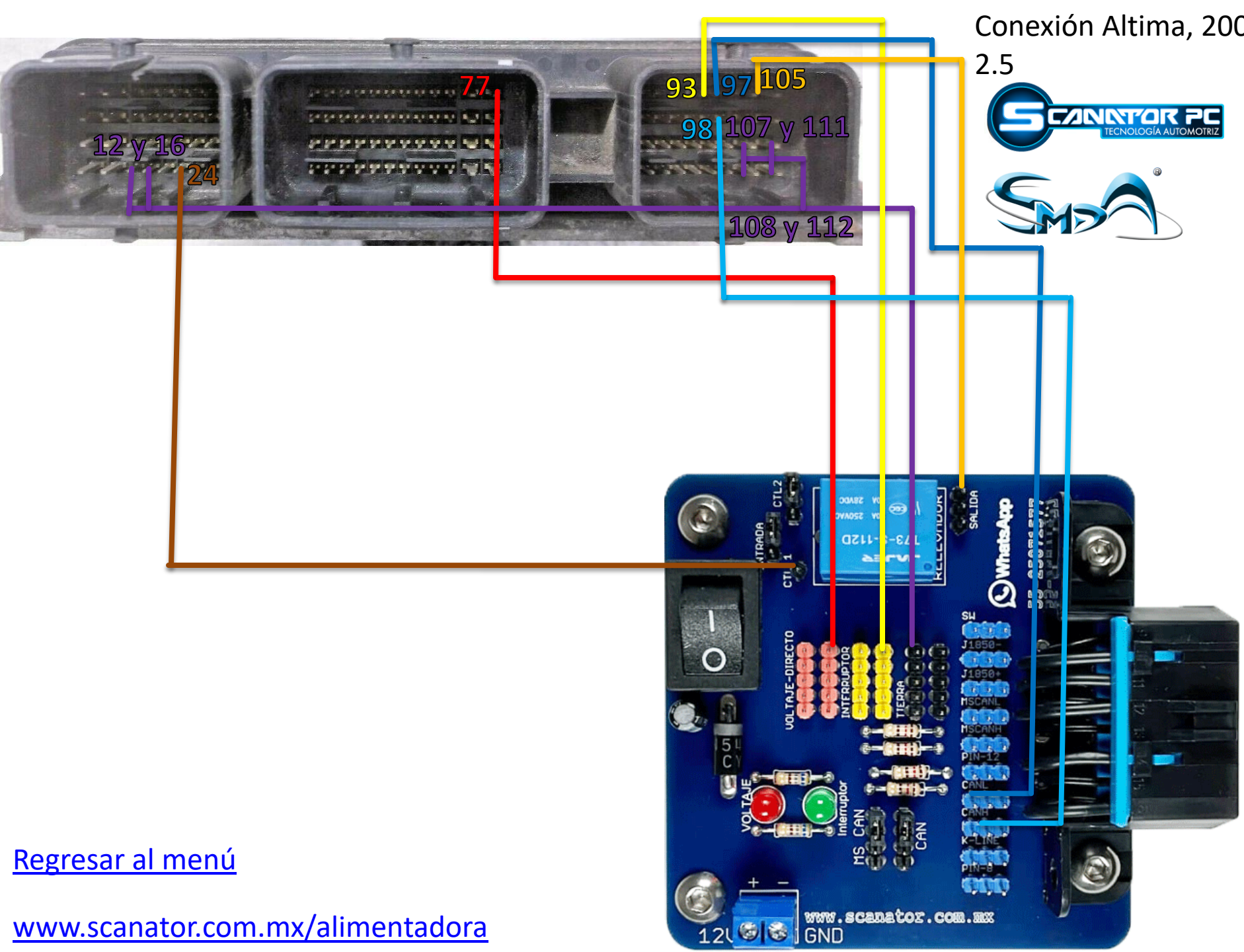

[Regresar al menú](#)

www.scanator.com.mx/alimentadora

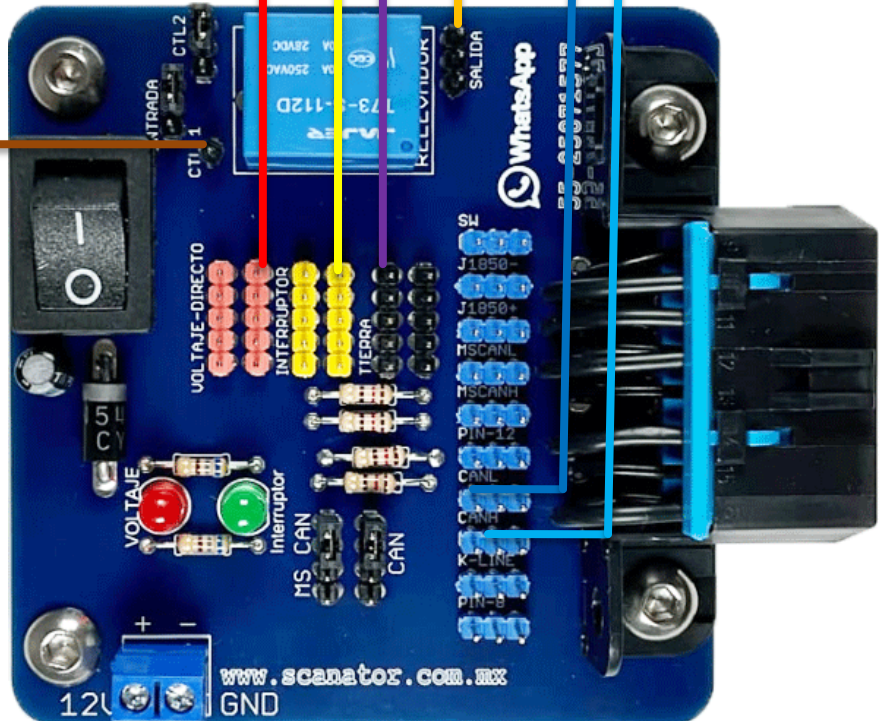

Conexión Focus, 2004
2.0

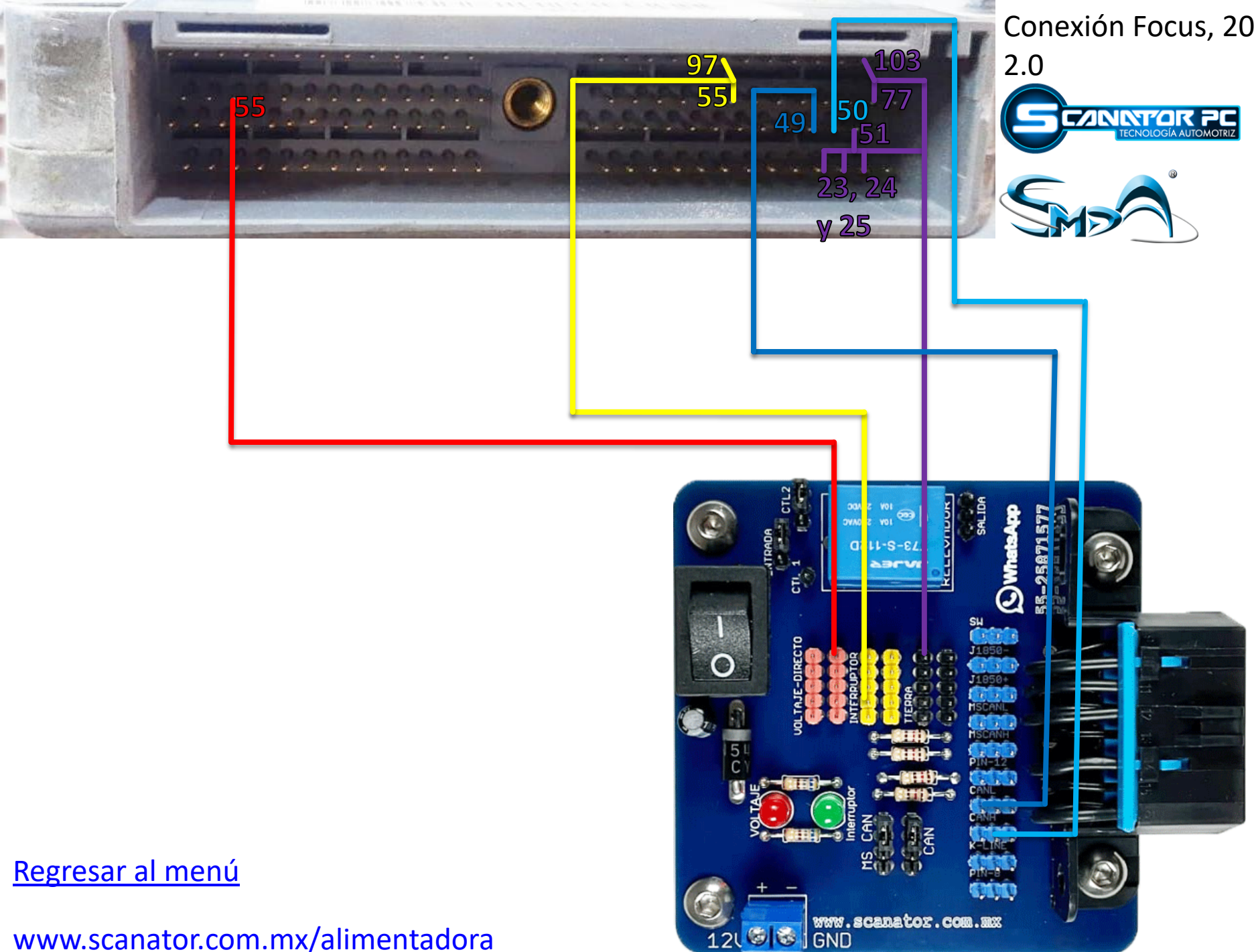

[Regresar al menú](#)

www.scanator.com.mx/alimentadora

ECU Hyundai Atos
2002-2010

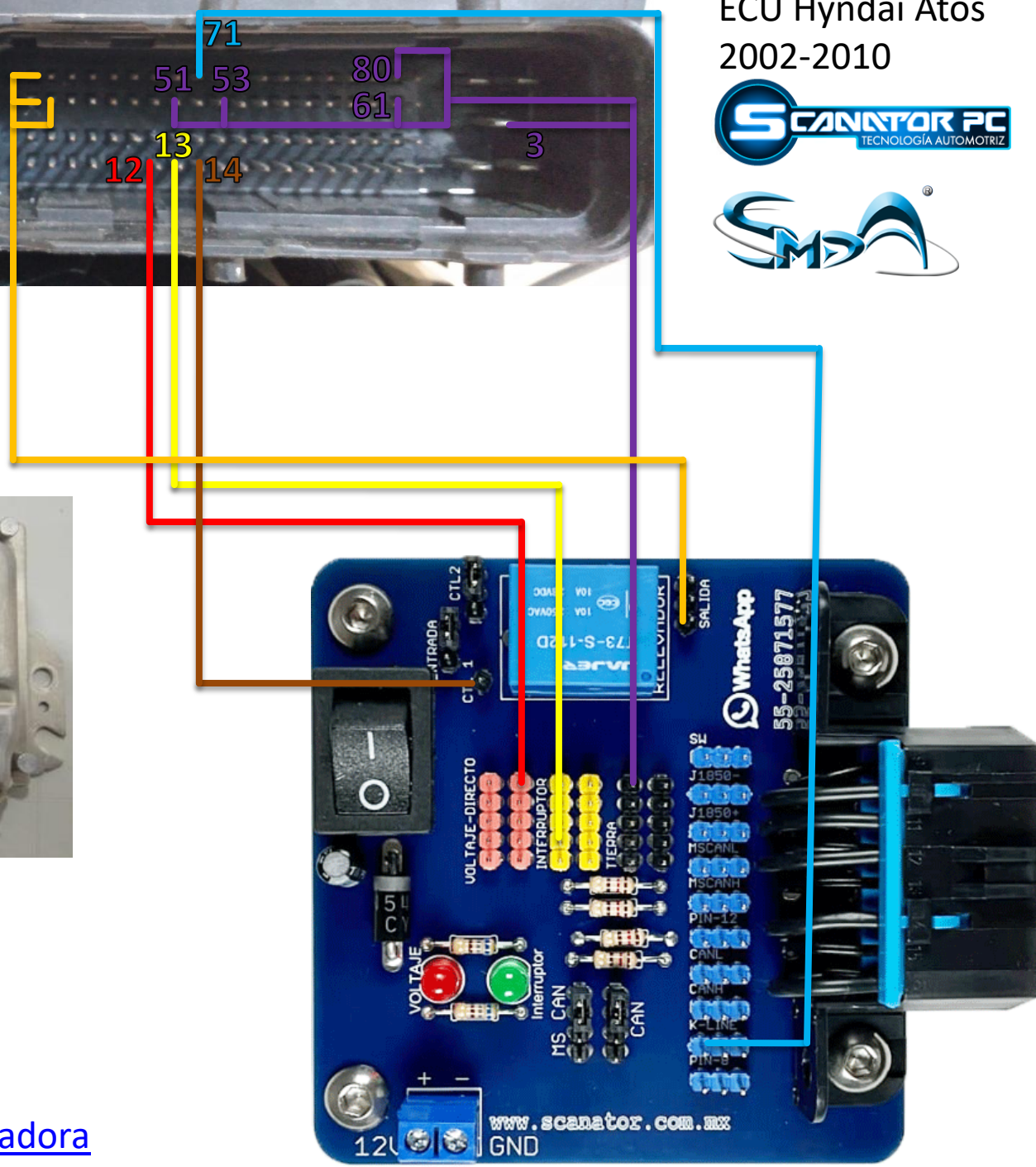
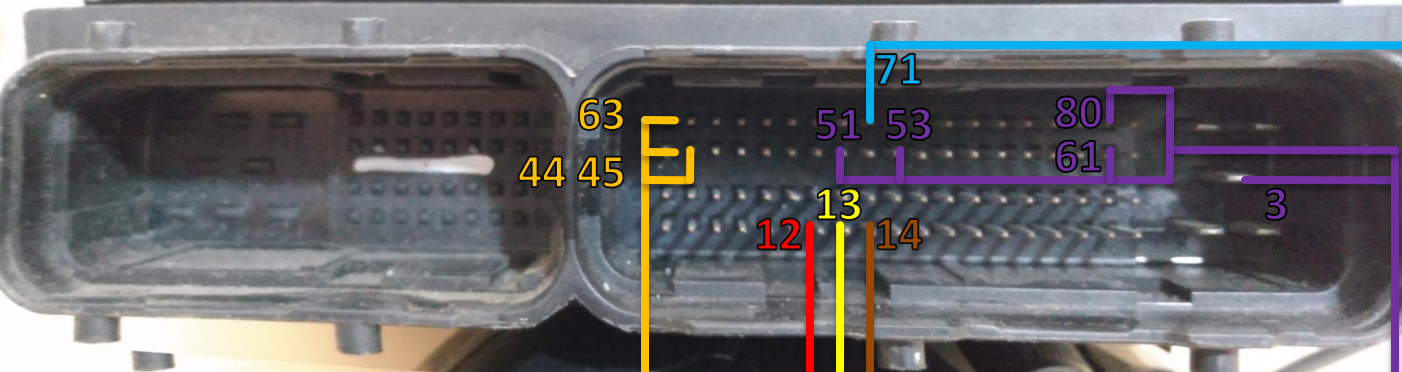

[Regresar al menú](#)

www.scanator.com.mx/alimentadora

ECU Spark
2010

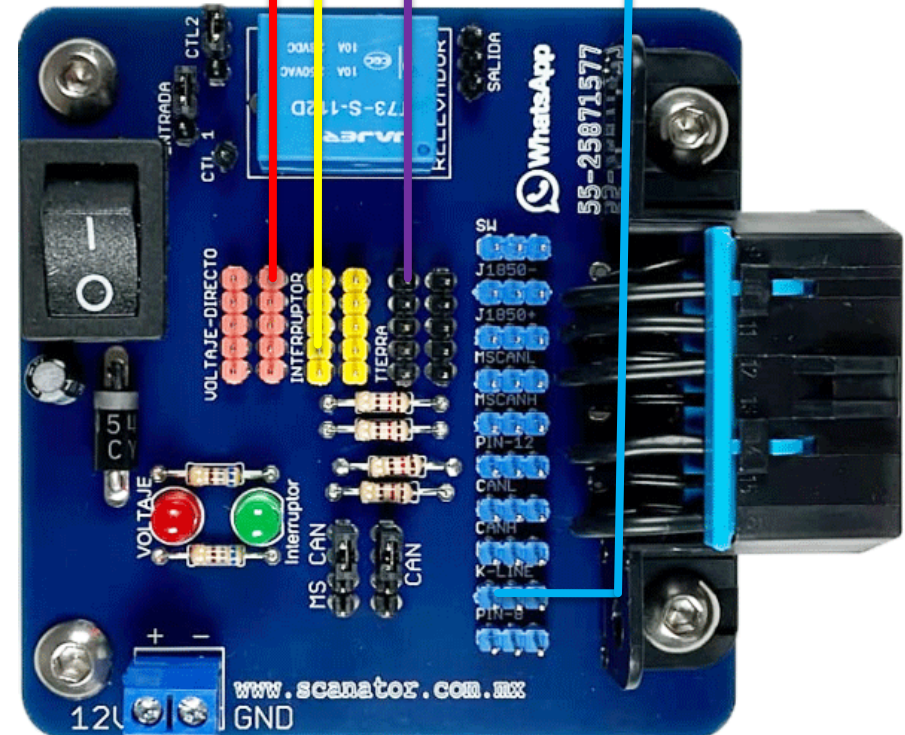

[Regresar al menú](#)

www.scanator.com.mx/alimentadora

ECU Ford Ranger 2.2

EMS 2204 / EMS 2207 / EMS 2211

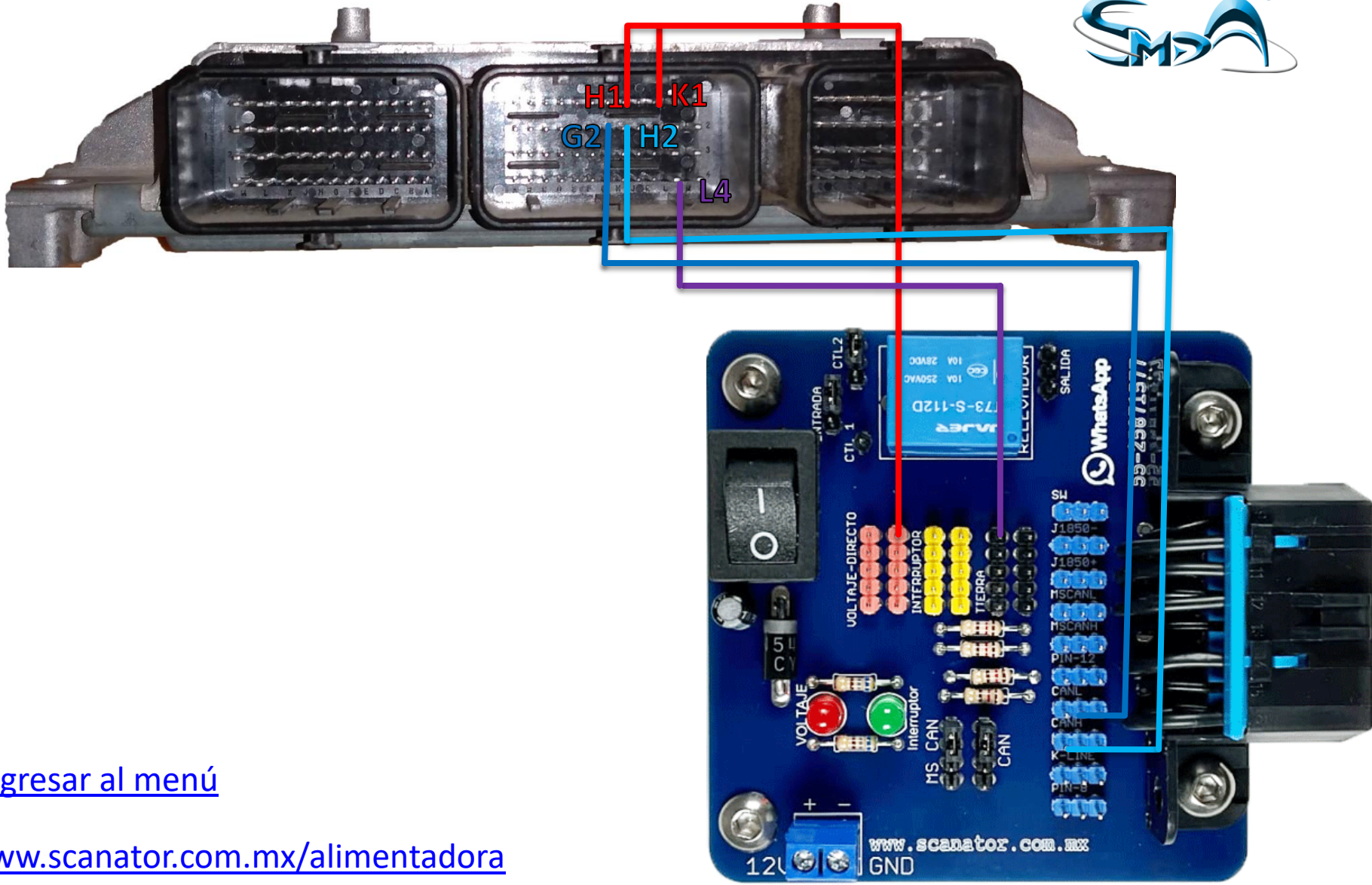

[Regresar al menú](#)

www.scanator.com.mx/alimentadora

www.scanator.com.mx

12V GND

TCM Ford – Lincoln Navigator NC 6R80

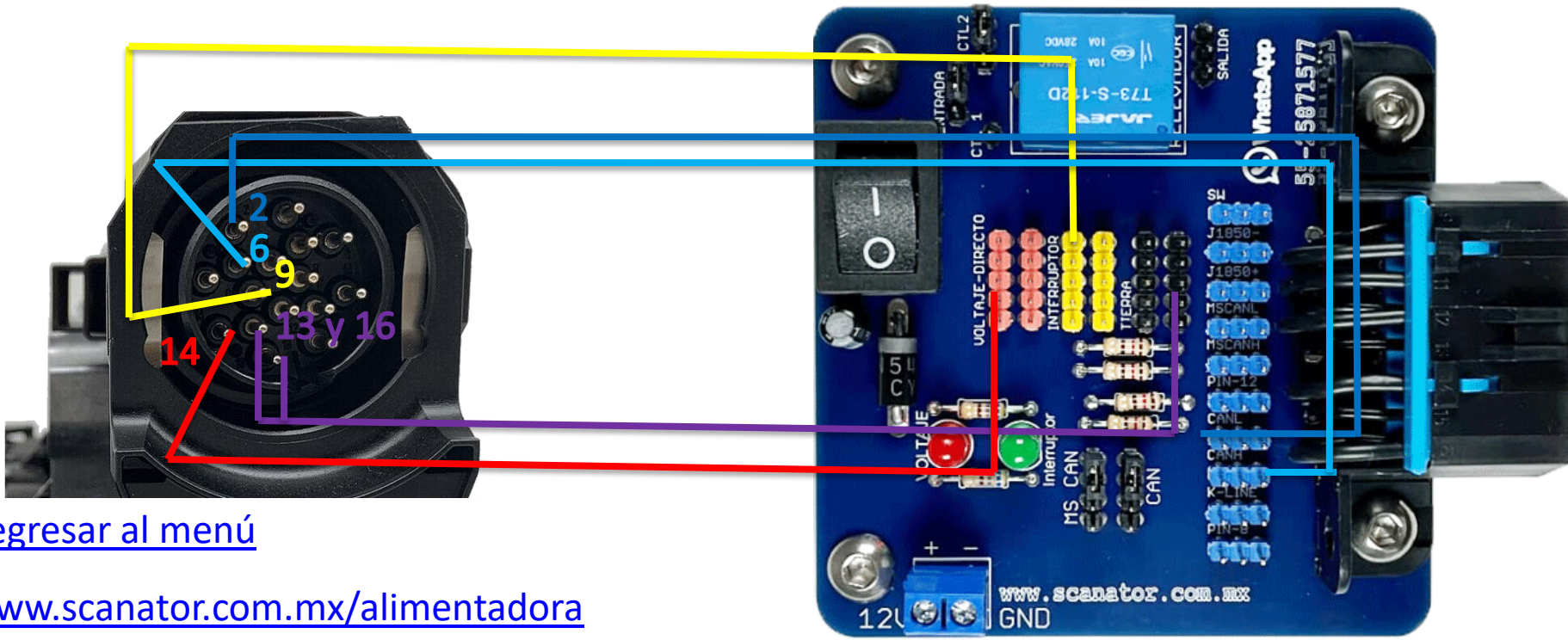

[Regresar al menú](#)

www.scanator.com.mx/alimentadora

ECU Ford Focus 2.0 2012-2016

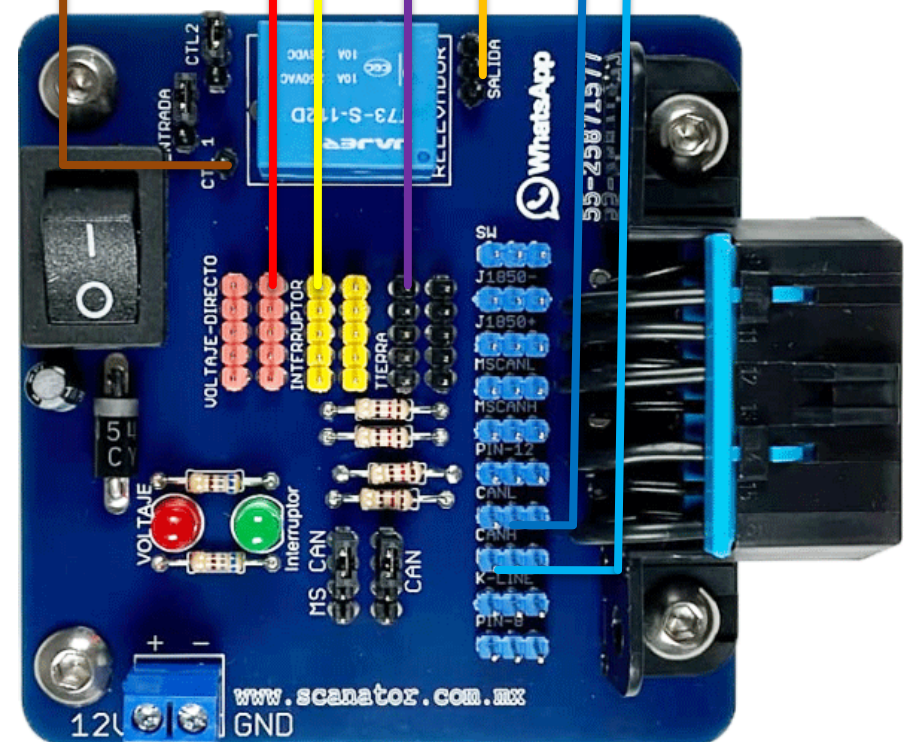
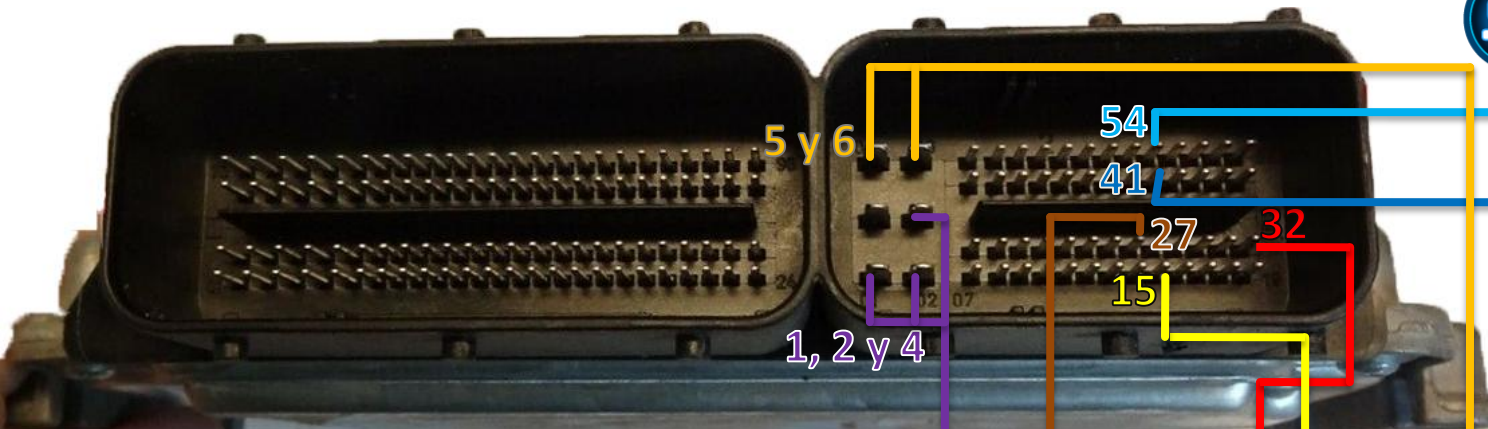

[Regresar al menú](#)

www.scanator.com.mx/alimentadora

ECU RAM 700
IAW 55F3 / IAW 55F8 / IAW 55F9

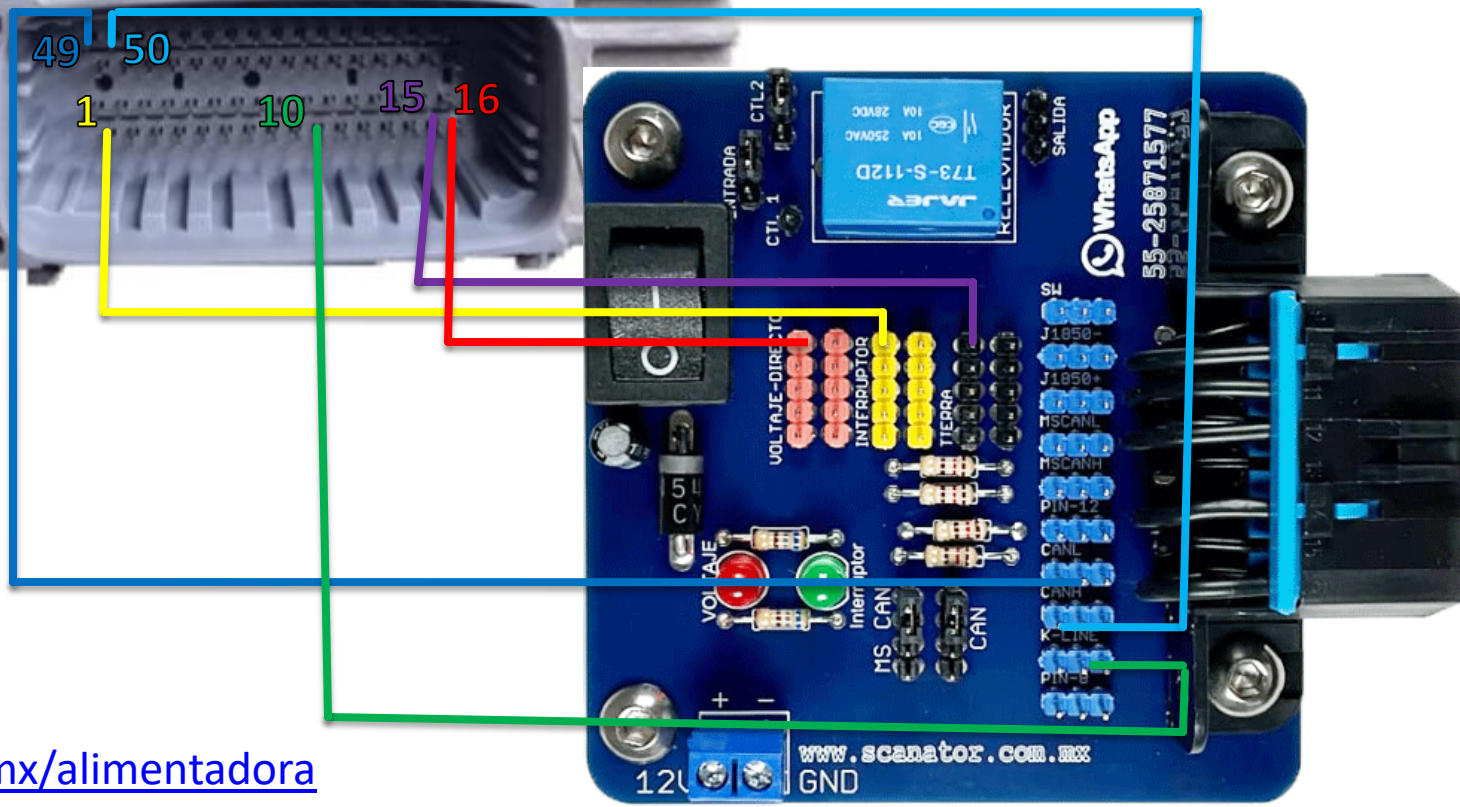

[Regresar al menú](#)

www.scanator.com.mx/alimentadora

Nissan Platina
Renault Scenic

ECU 90 pines

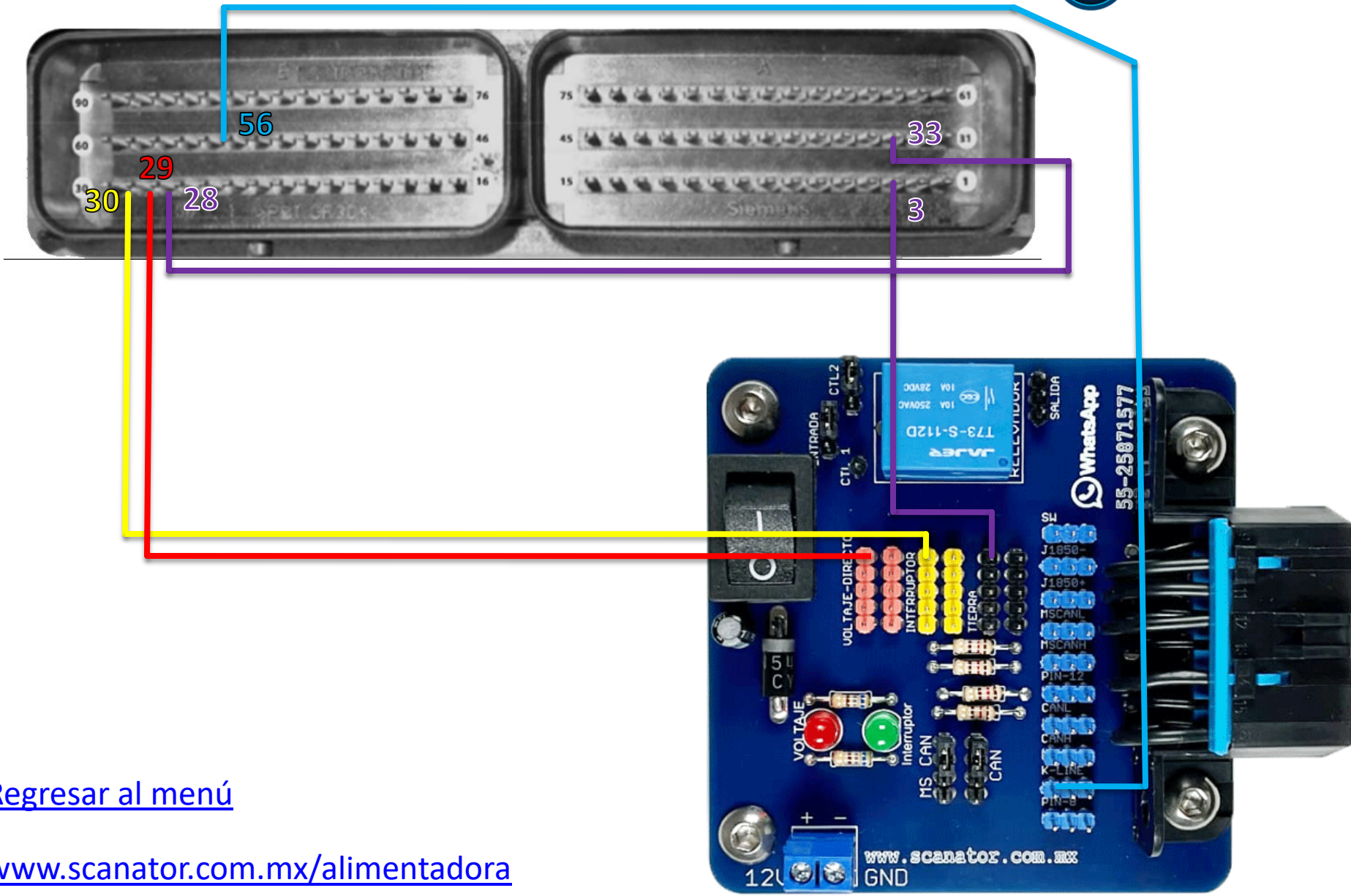

[Regresar al menú](#)

www.scanator.com.mx/alimentadora

ECU Ford EEC V

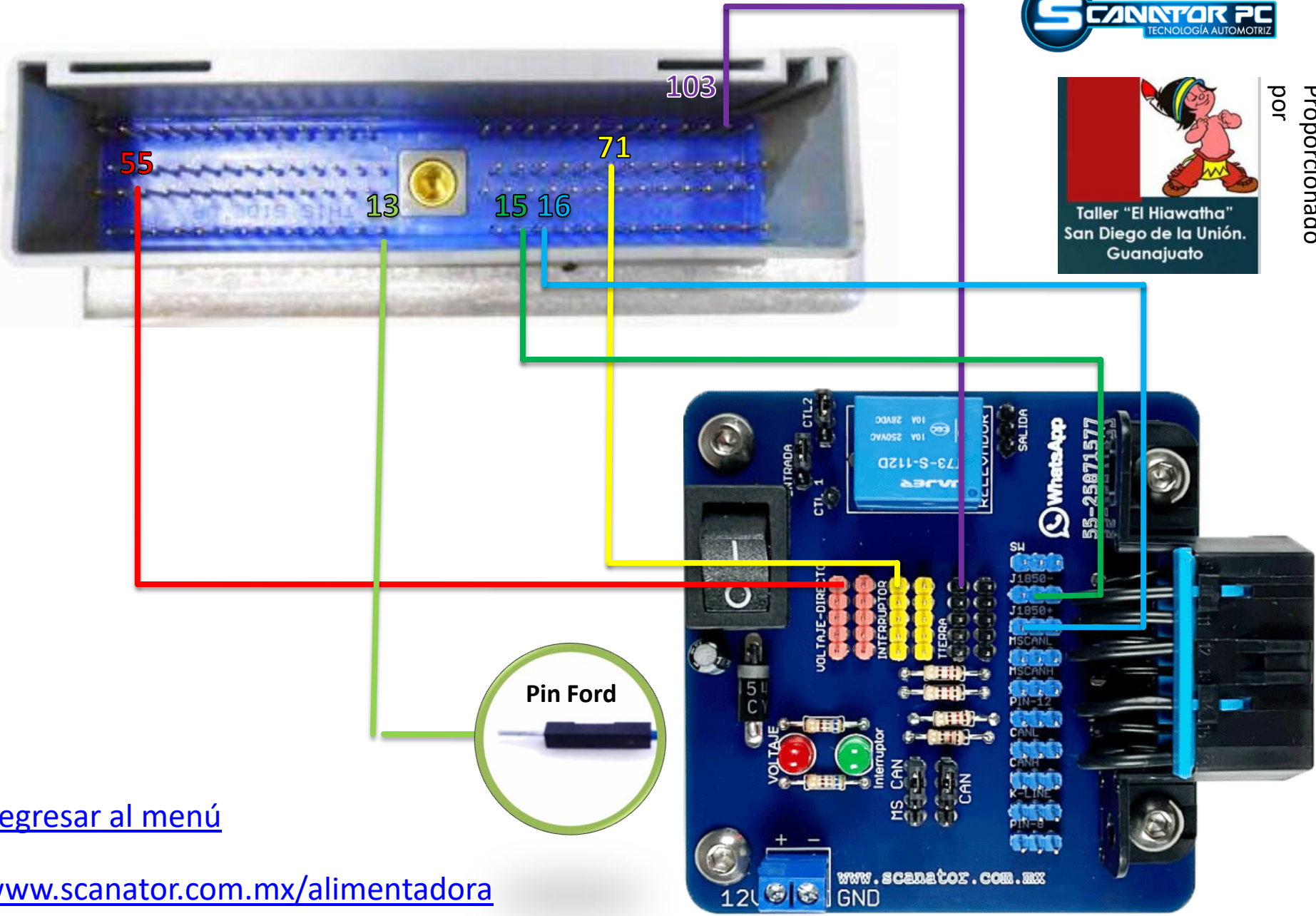

Proporcionado por

[Regresar al menú](#)

www.scanator.com.mx/alimentadora

www.scanator.com.mx

12V GND

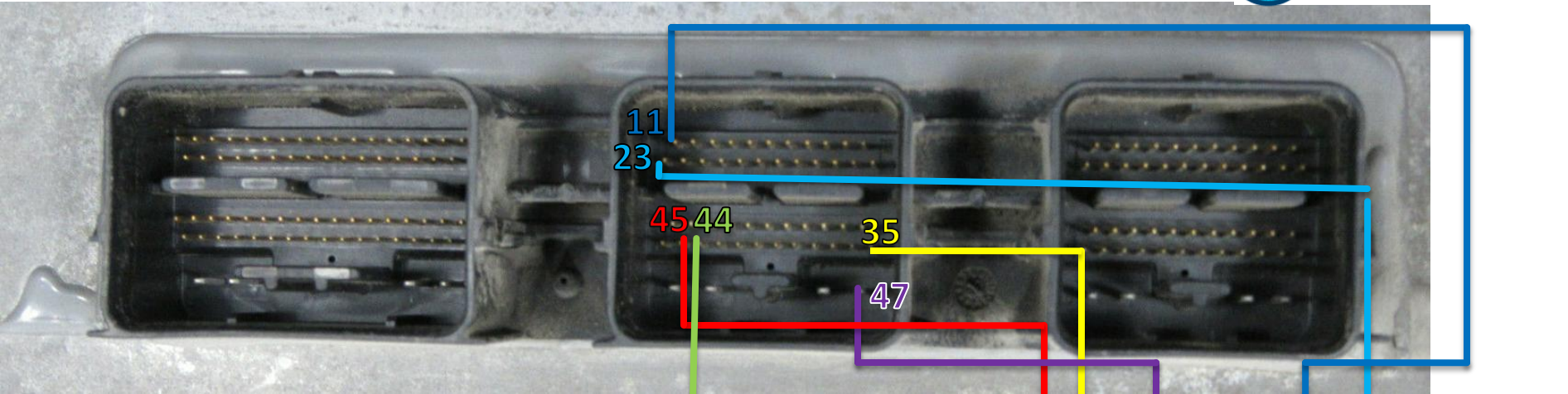

Proporcionado por

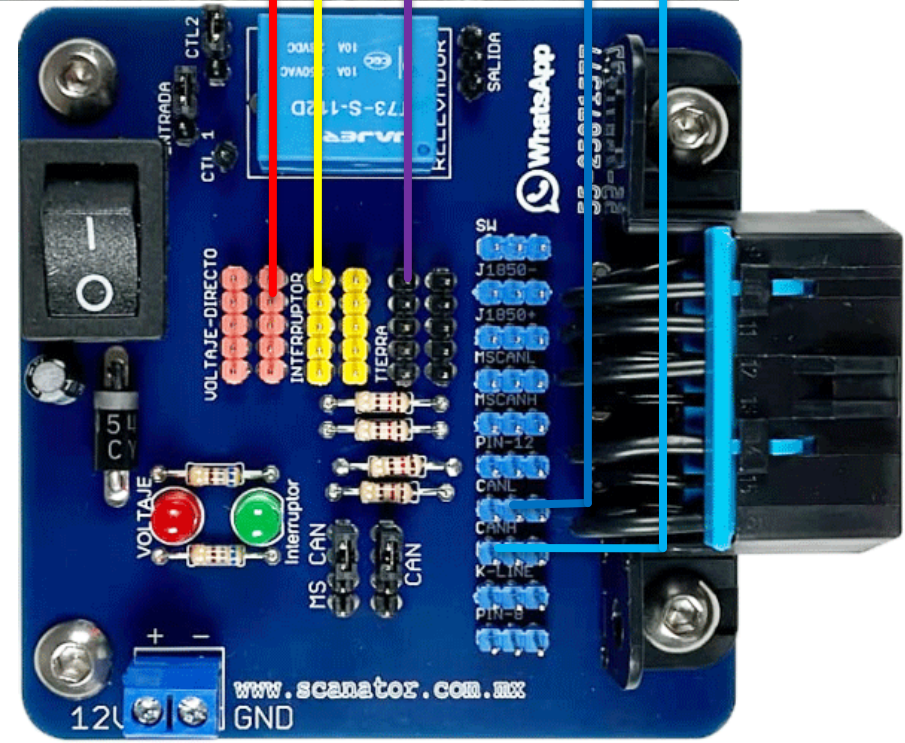

[Regresar al menú](#)

www.scanator.com.mx/alimentadora

ECU Ford Black OAK 1472k

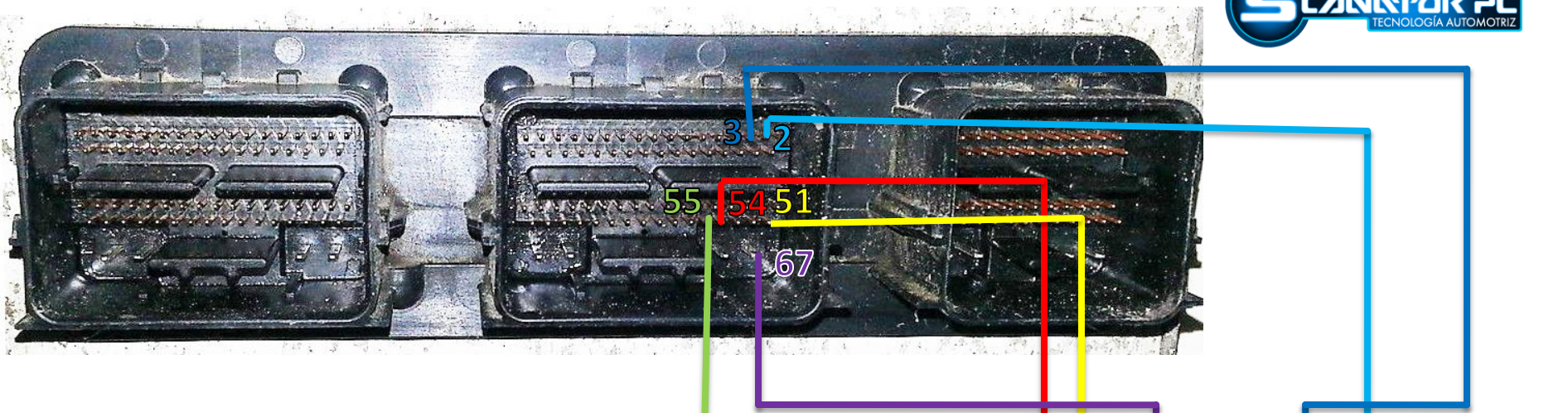

Proporcionado por

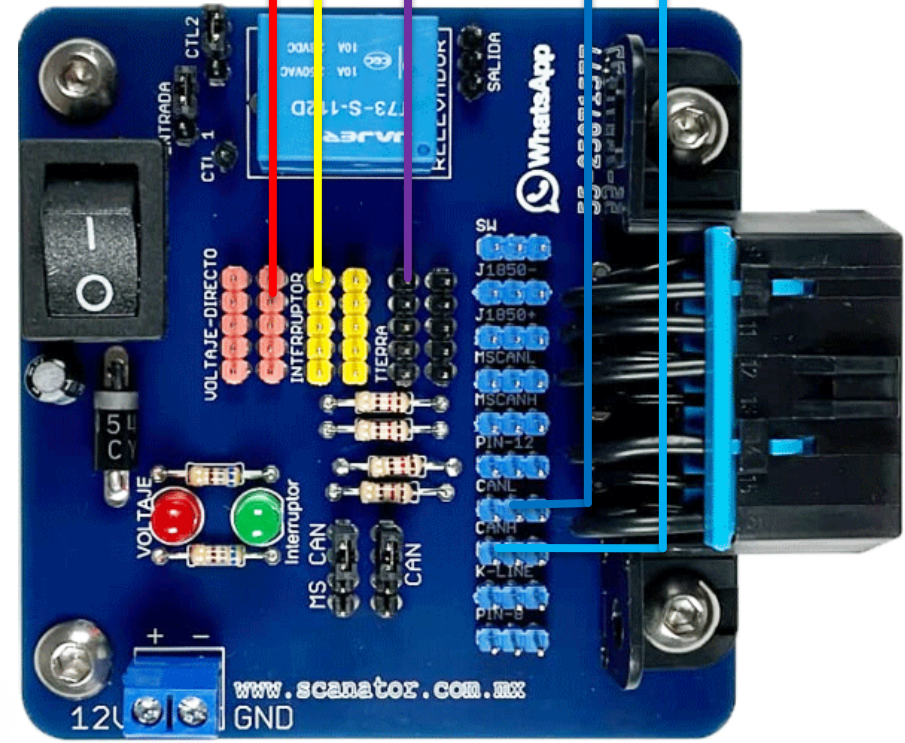

[Regresar al menú](#)

www.scanator.com.mx/alimentadora

ECU Ford Green OAK 2368k

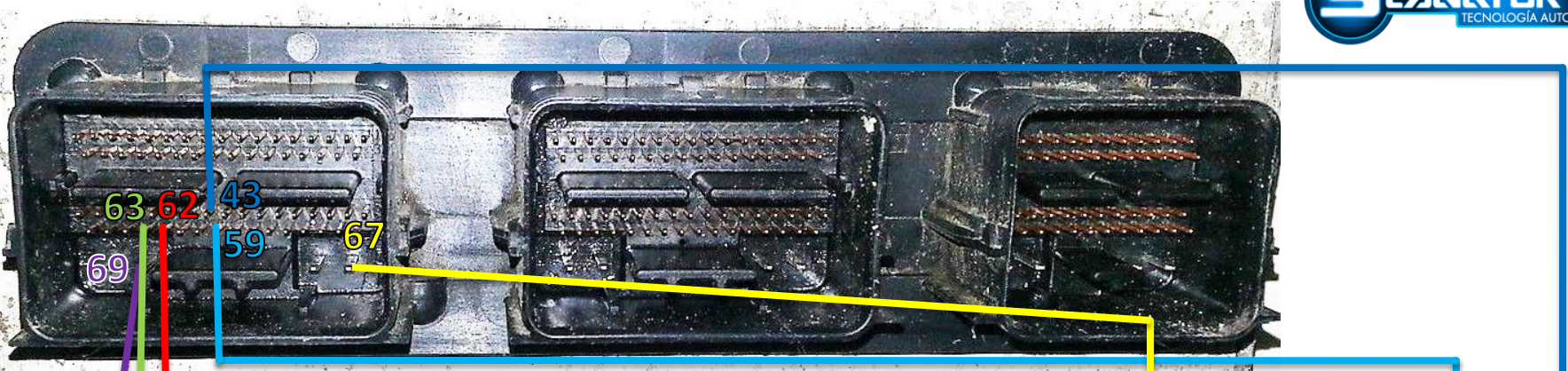

Proporcionado por

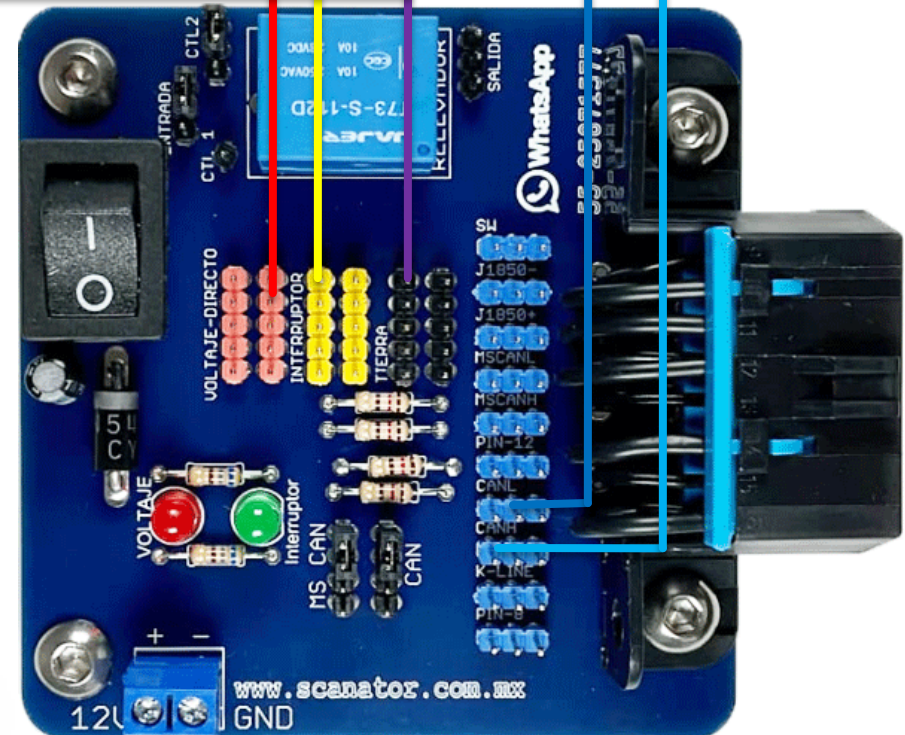

[Regresar al menú](#)

www.scanator.com.mx/alimentadora

ECU Ford copperhead / ESYS

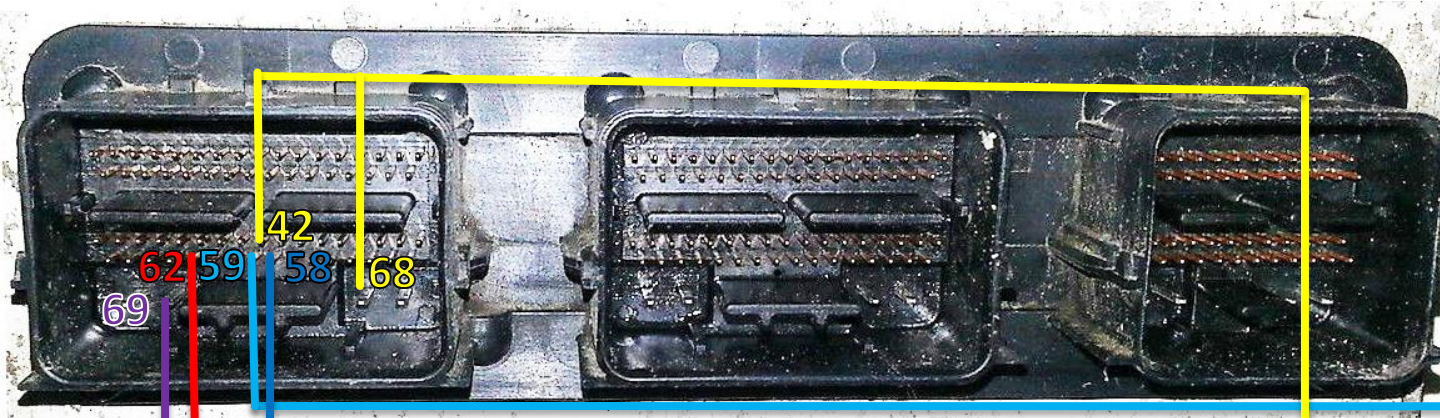

Proporcionado por

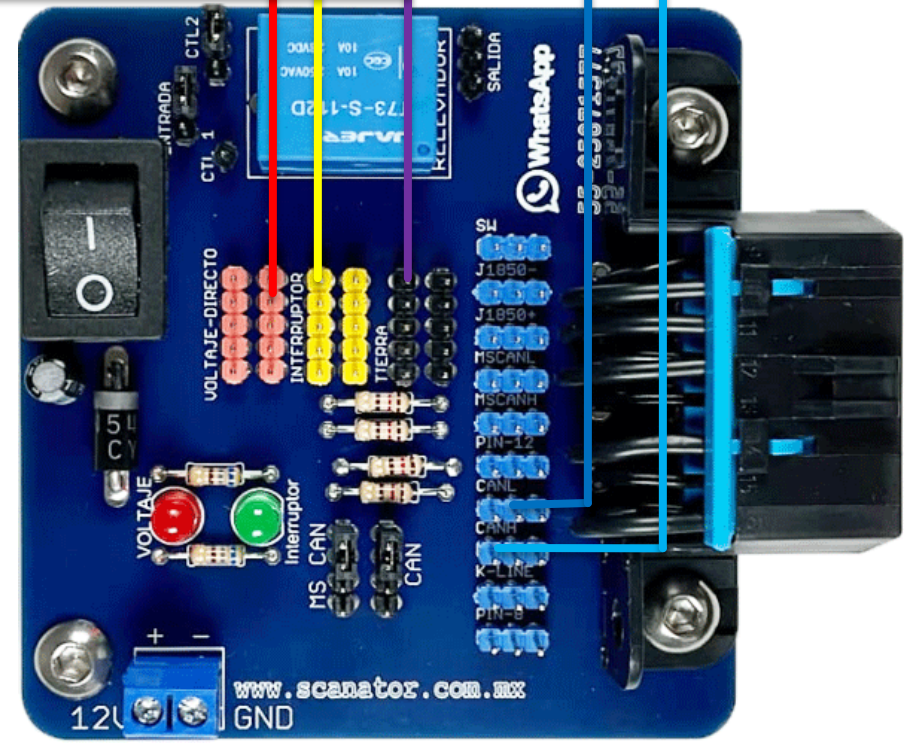

[Regresar al menú](#)

www.scanator.com.mx/alimentadora

ECU Ford continental Tricore Gen 2

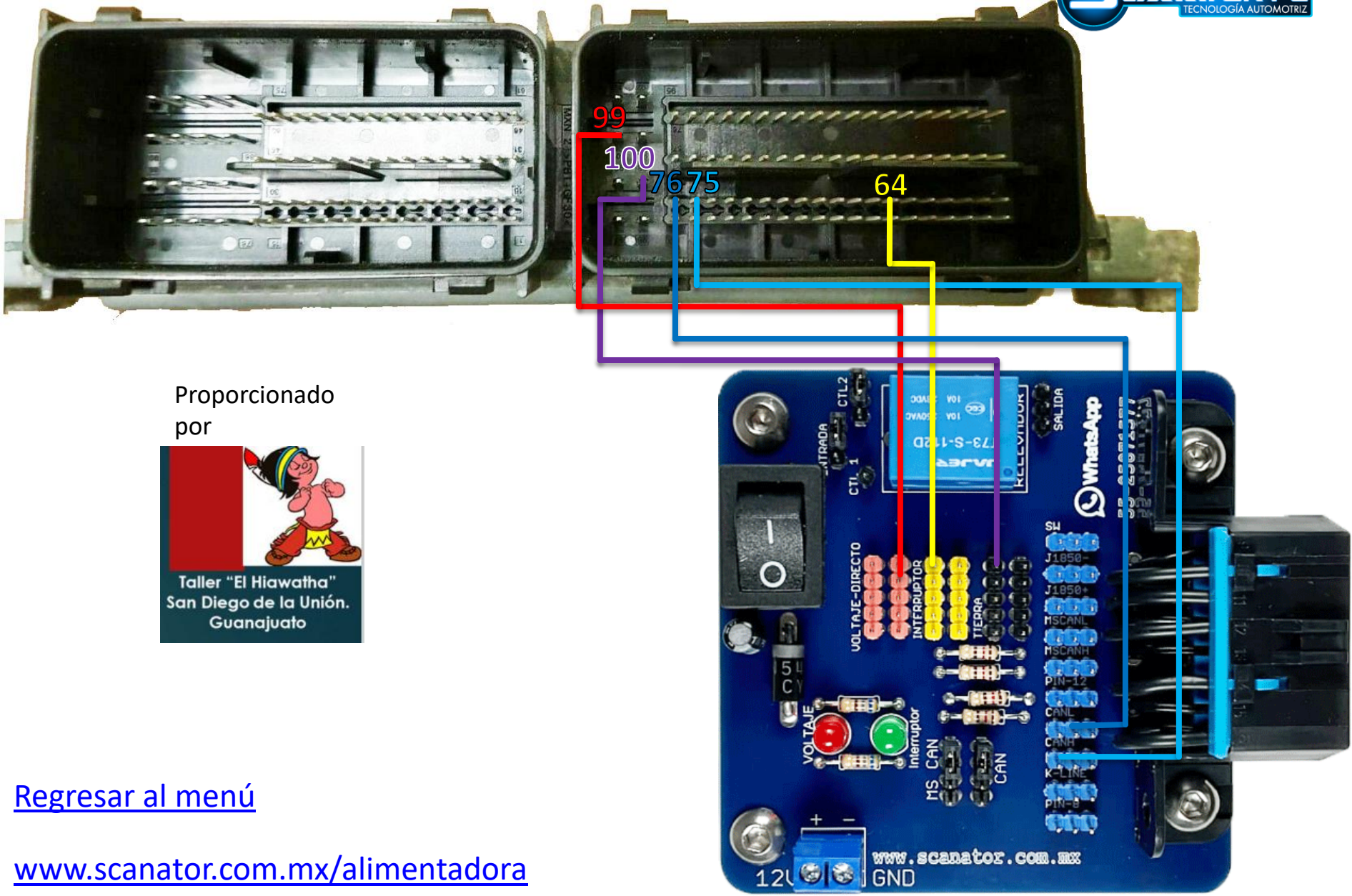

Proporcionado por



[Regresar al menú](#)

www.scanator.com.mx/alimentadora

ECU Ford Bosch Tricore Ecoboost

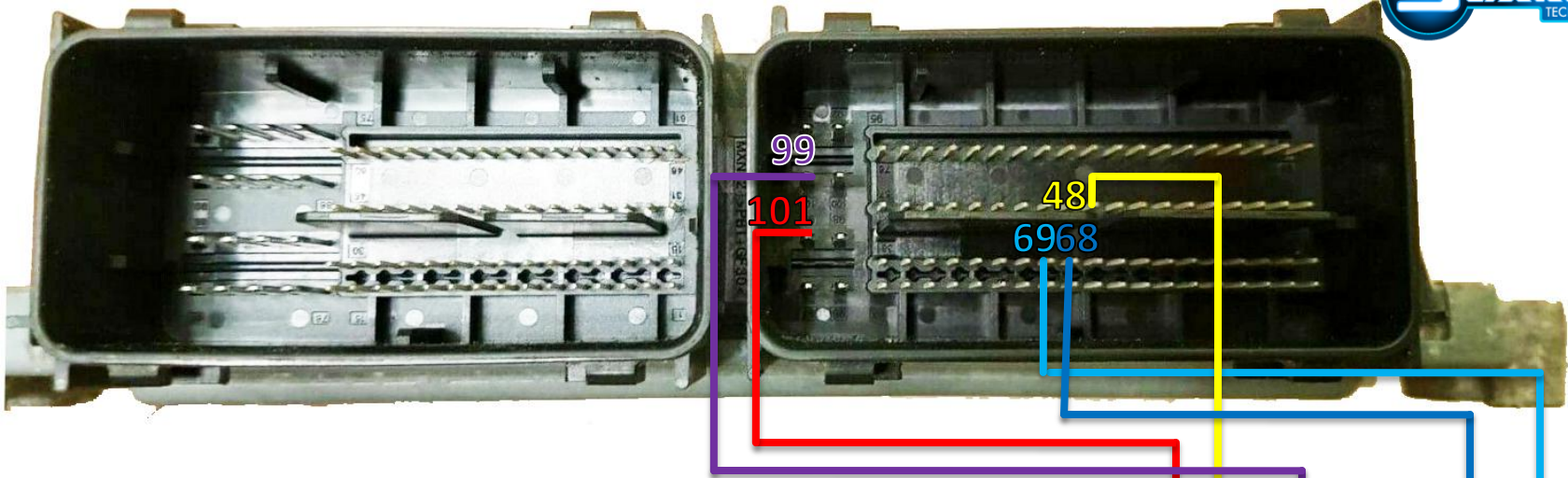

Proporcionado por

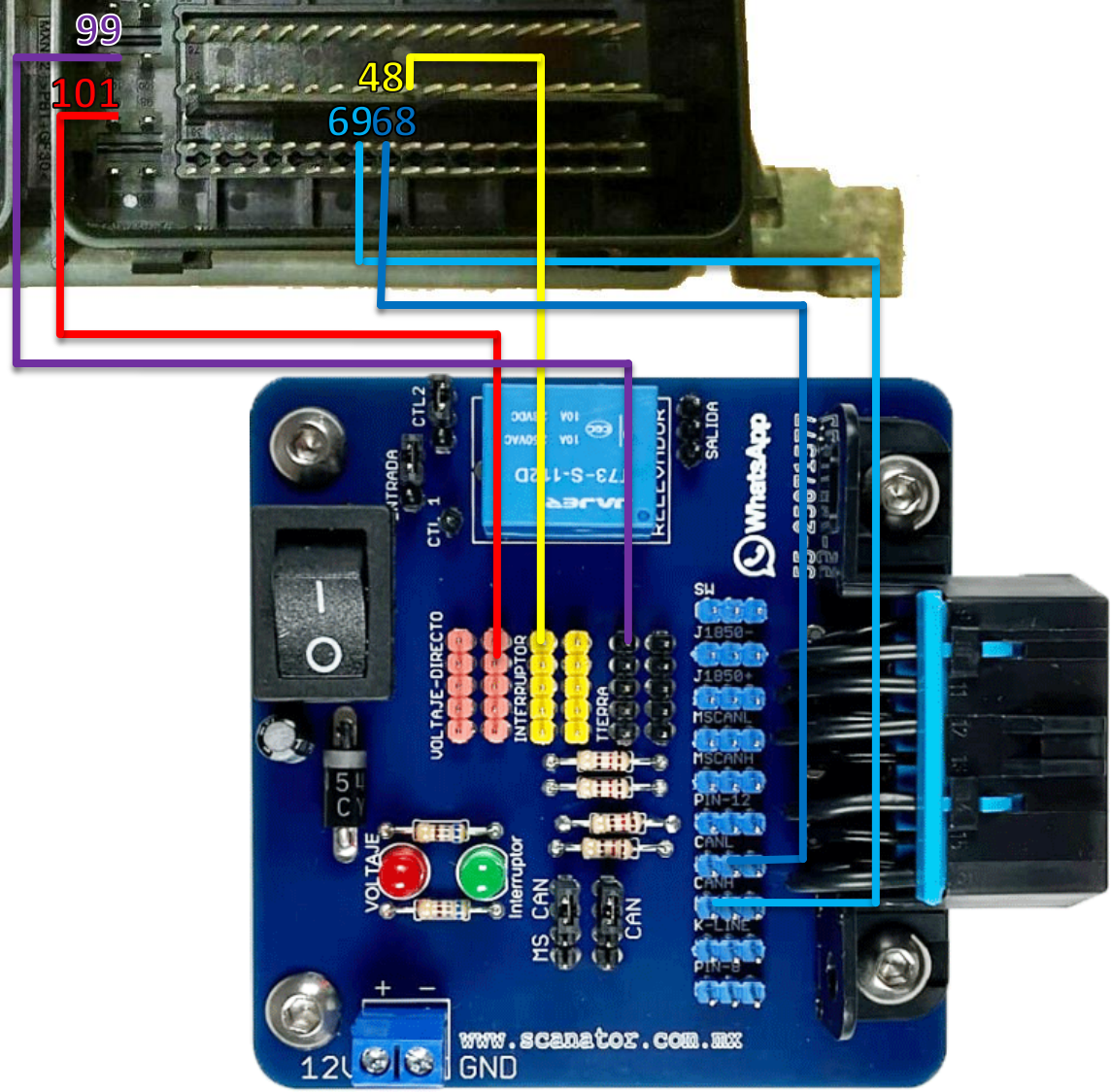

[Regresar al menú](#)

www.scanator.com.mx/alimentadora

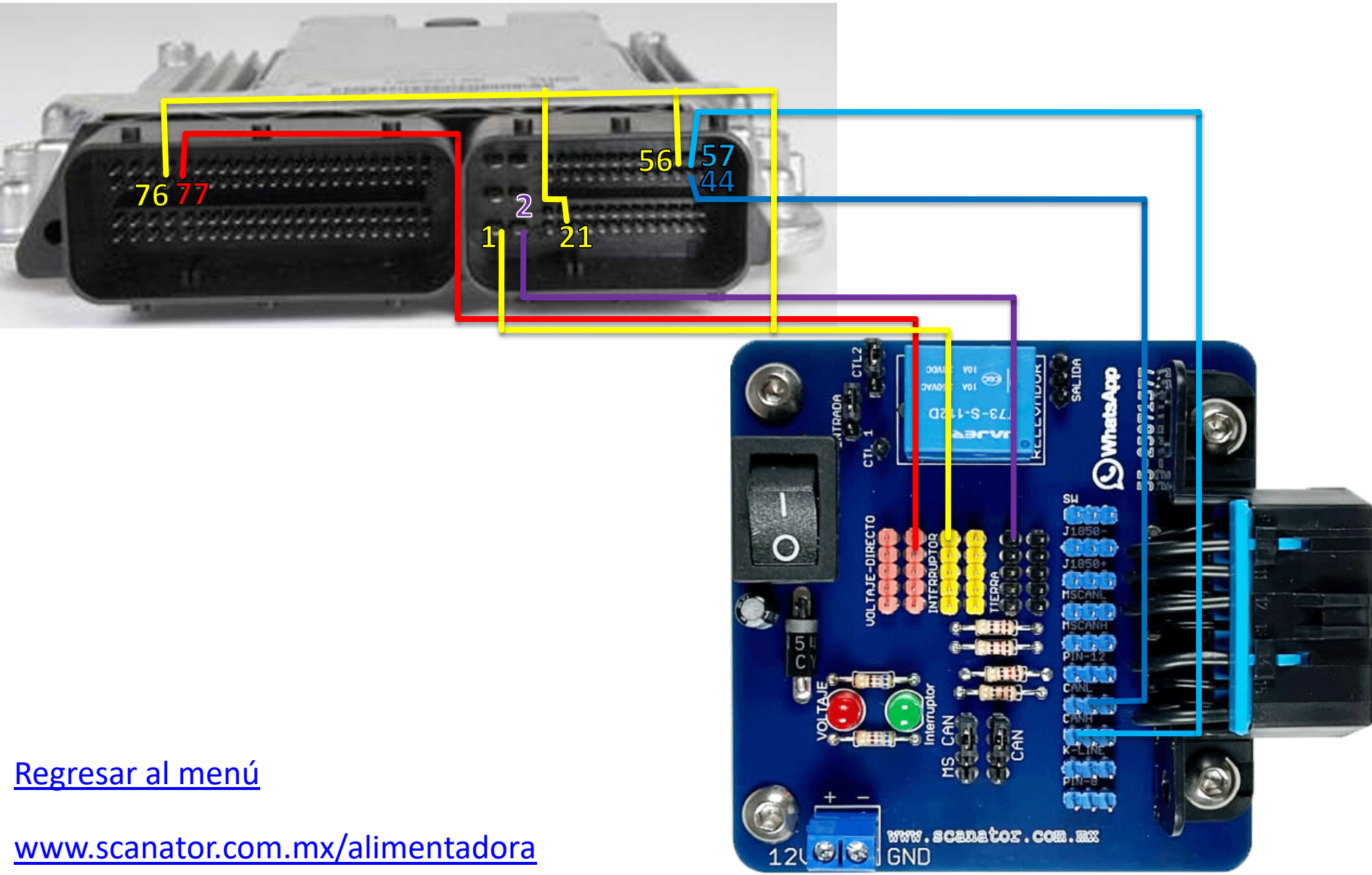

[Regresar al menú](#)

www.scanator.com.mx/alimentadora

ECU GM E40

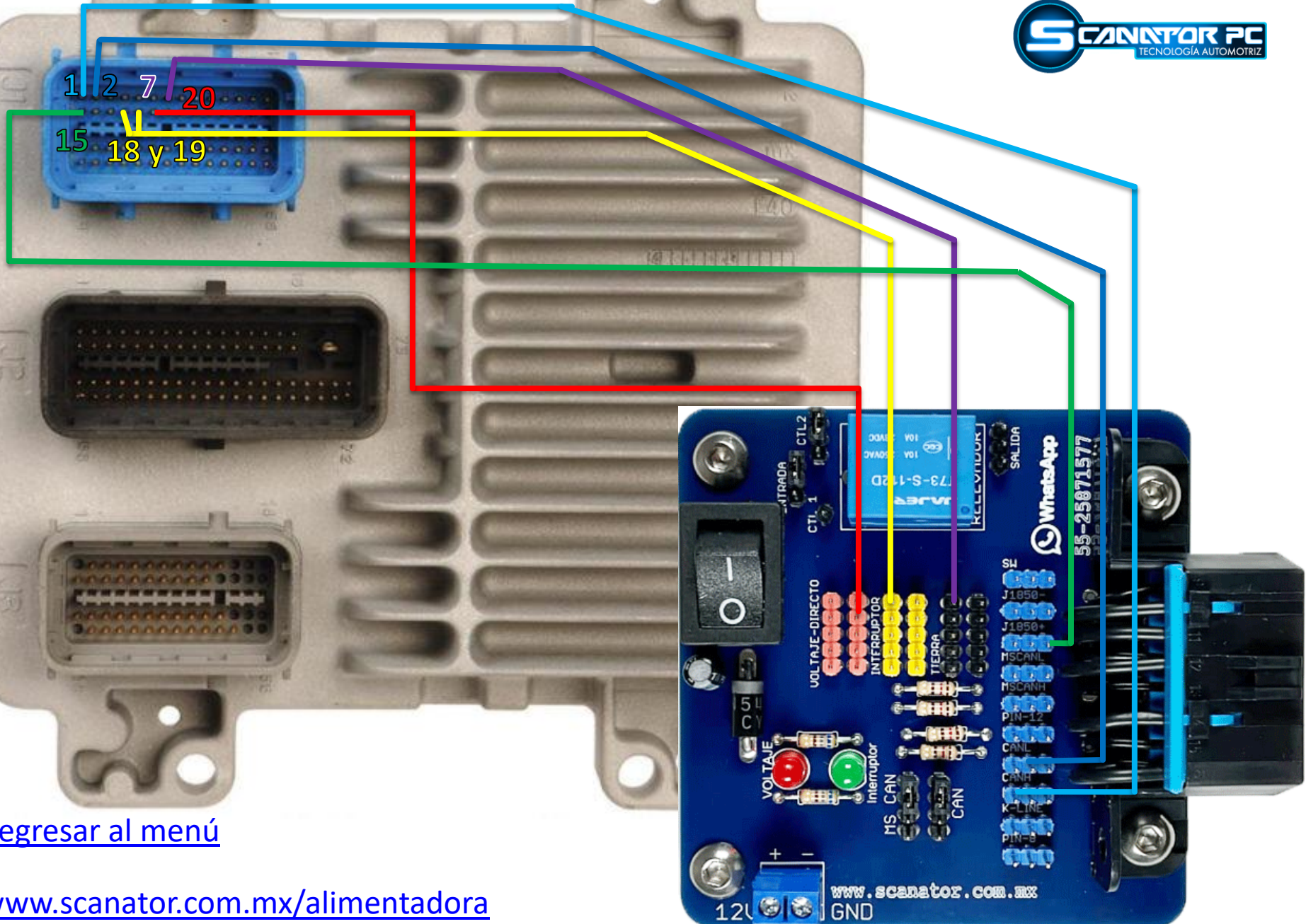

[Regresar al menú](#)

www.scanator.com.mx/alimentadora

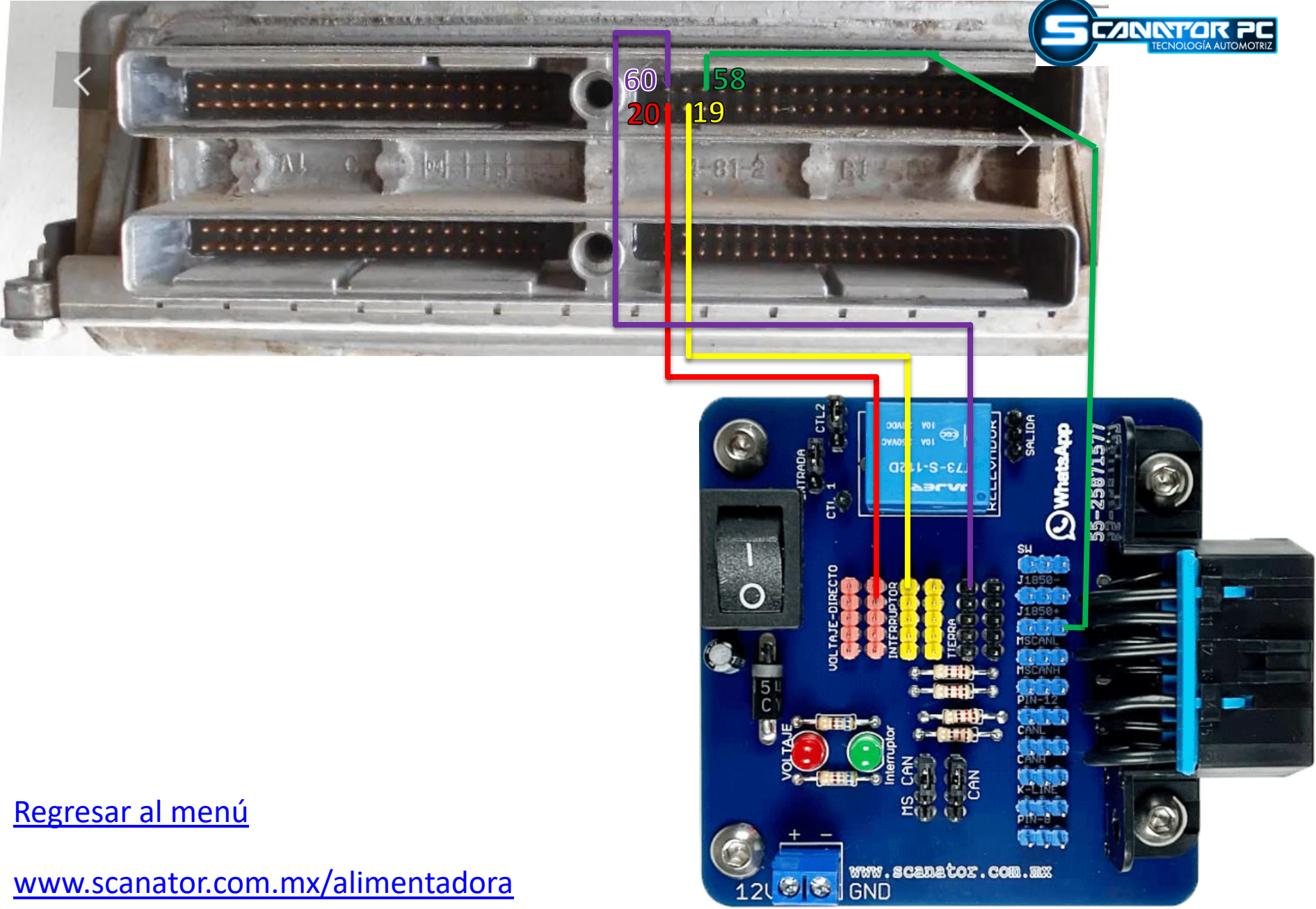

[Regresar al menú](#)

www.scanator.com.mx/alimentadora

ECU GM P10

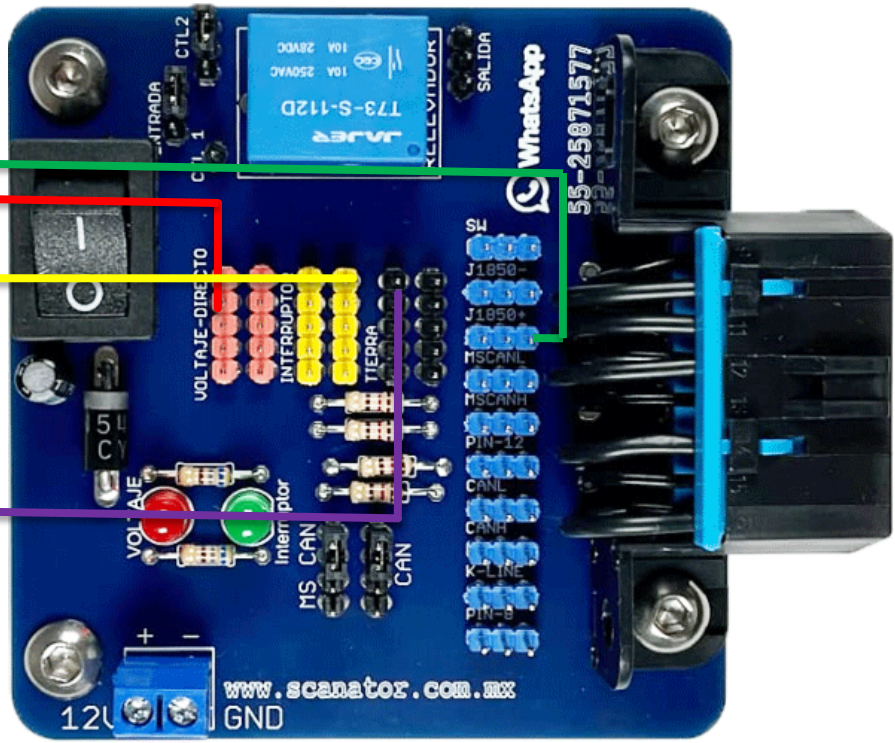
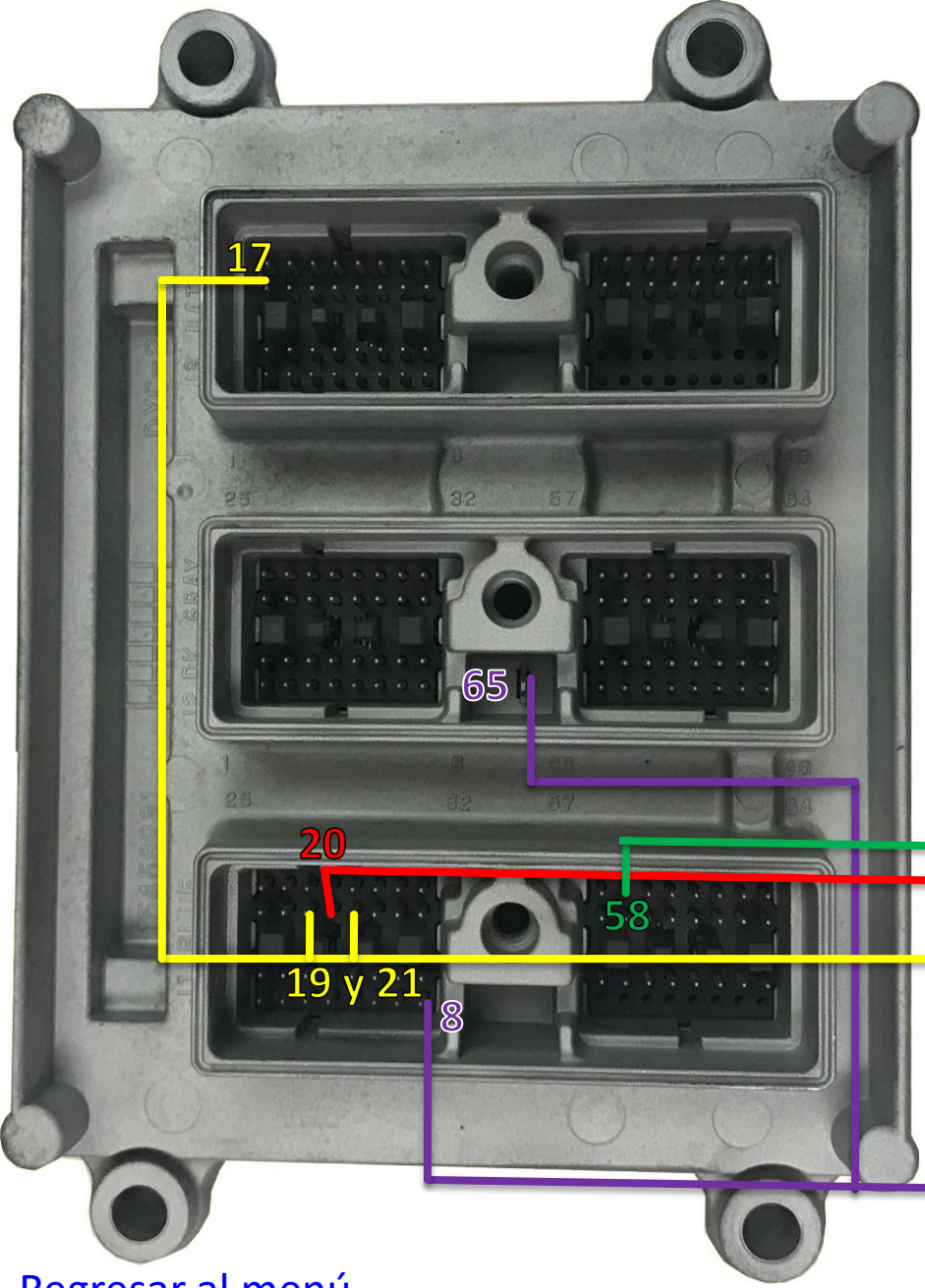

[Regresar al menú](#)

www.scanator.com.mx/alimentadora

ECU GM P12

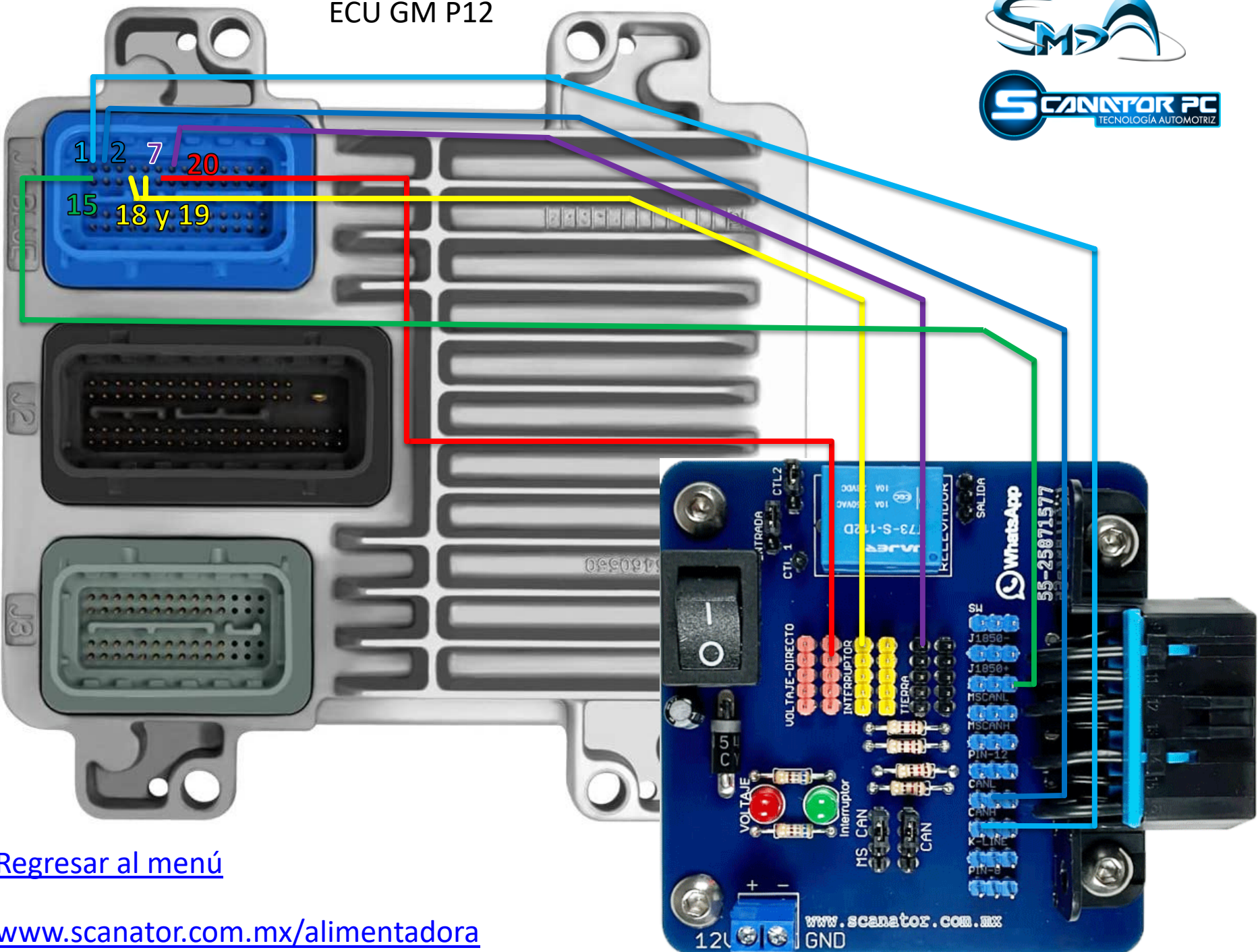

[Regresar al menú](#)

www.scanator.com.mx/alimentadora

Transmisión GM T42

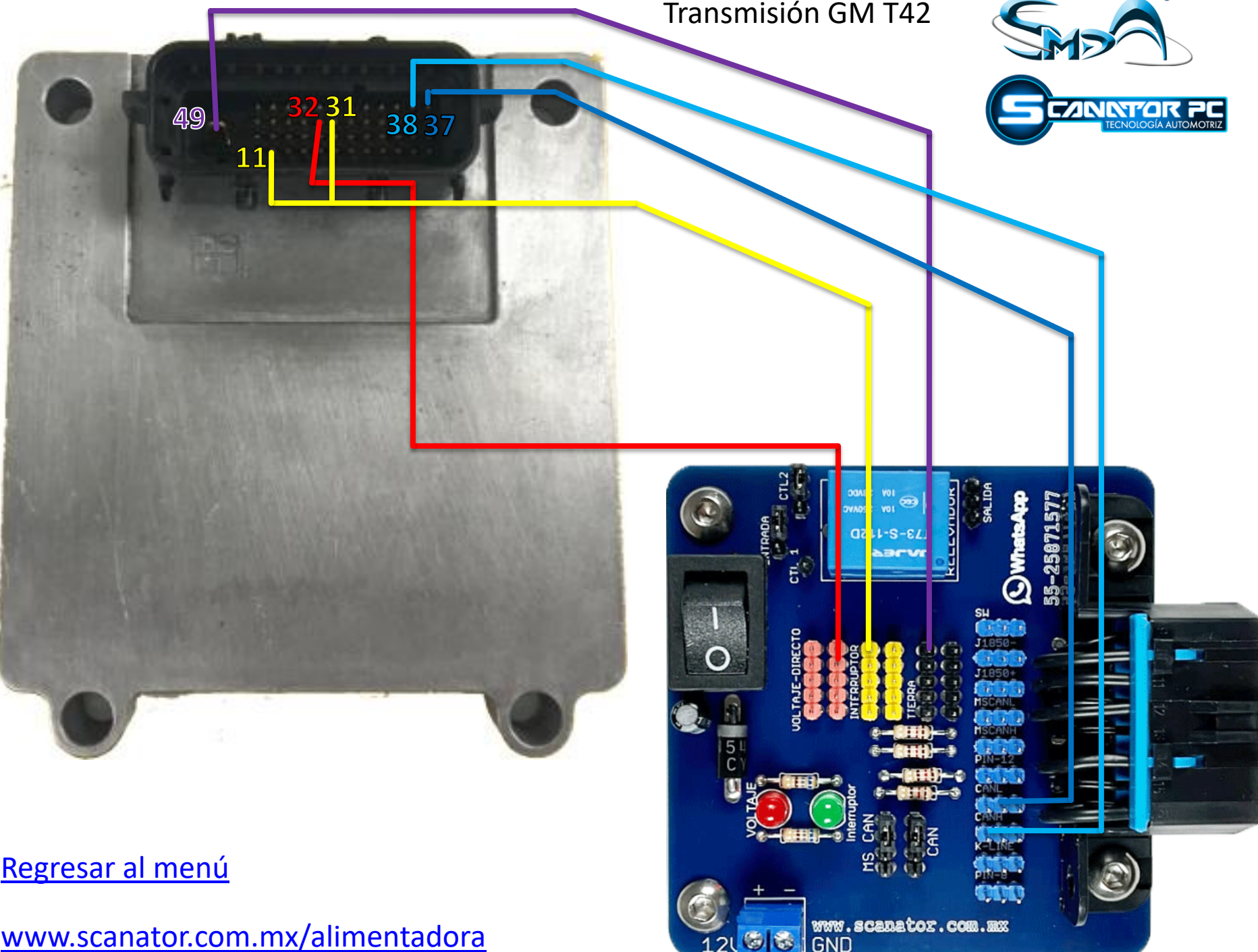

[Regresar al menú](#)

www.scanator.com.mx/alimentadora

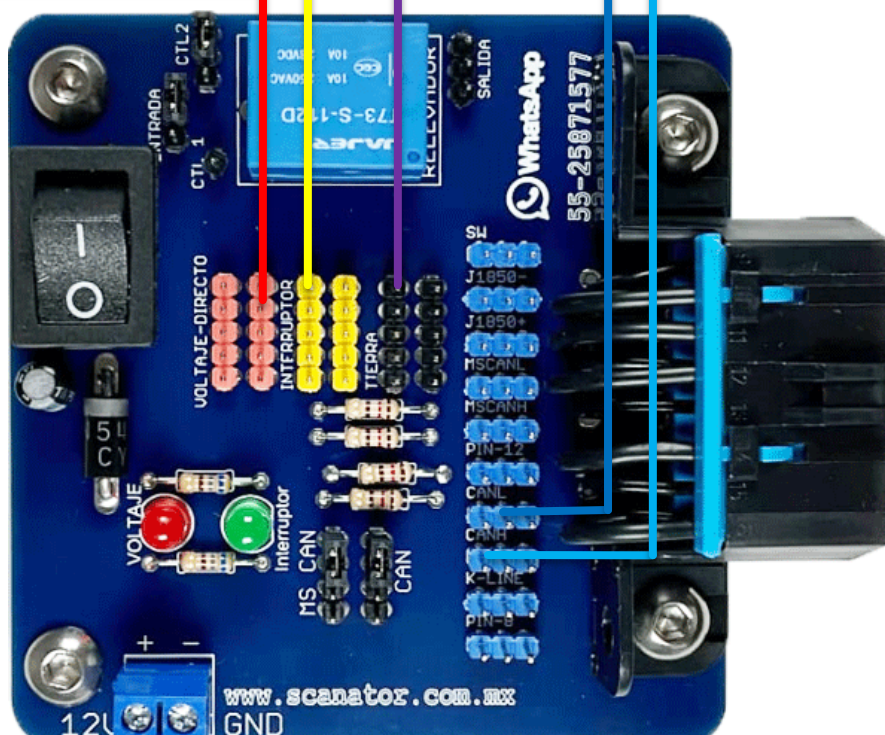

Allison 5 speed gearbox GM

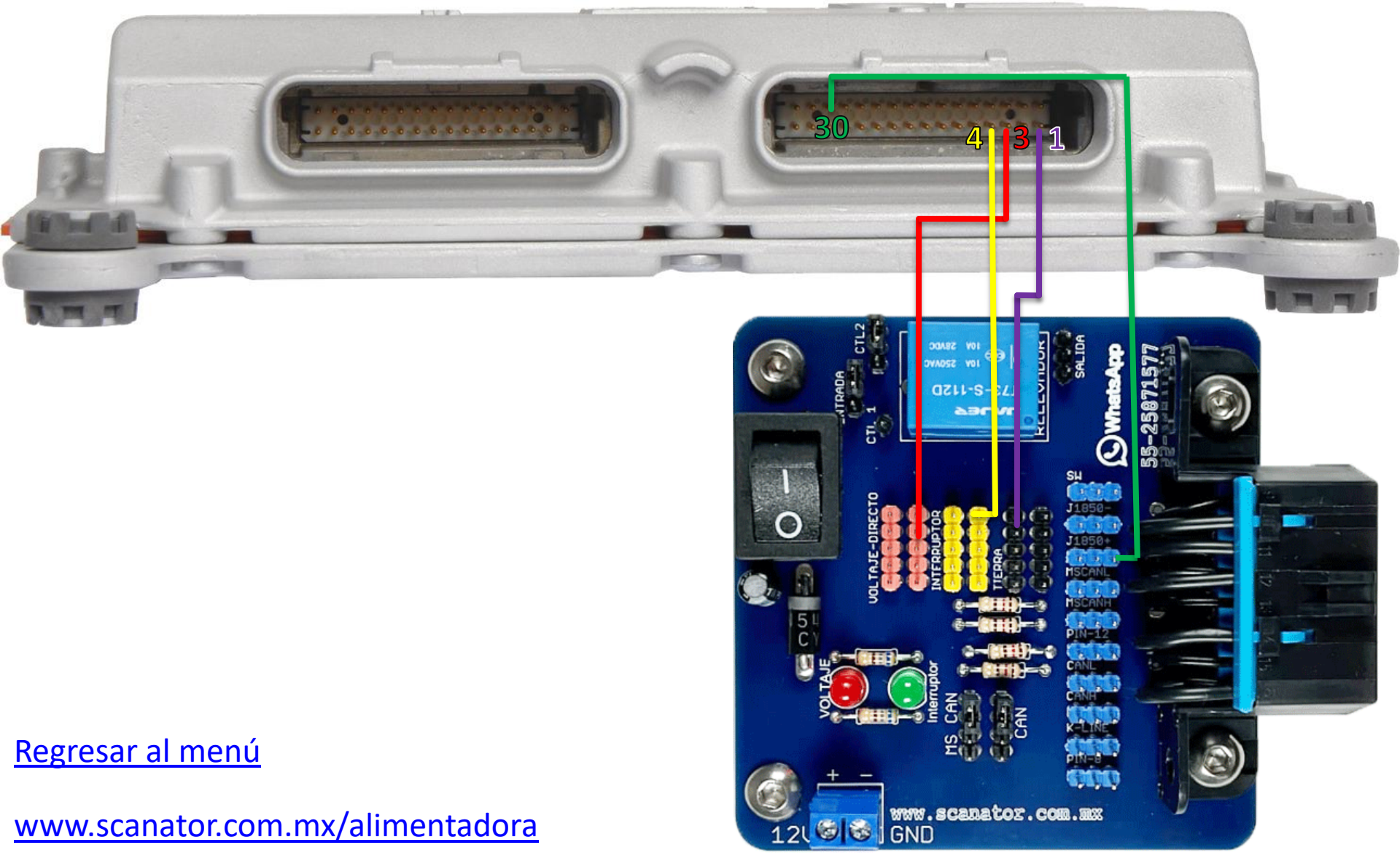

[Regresar al menú](#)

www.scanator.com.mx/alimentadora

Allison 6 speed gearbox GM

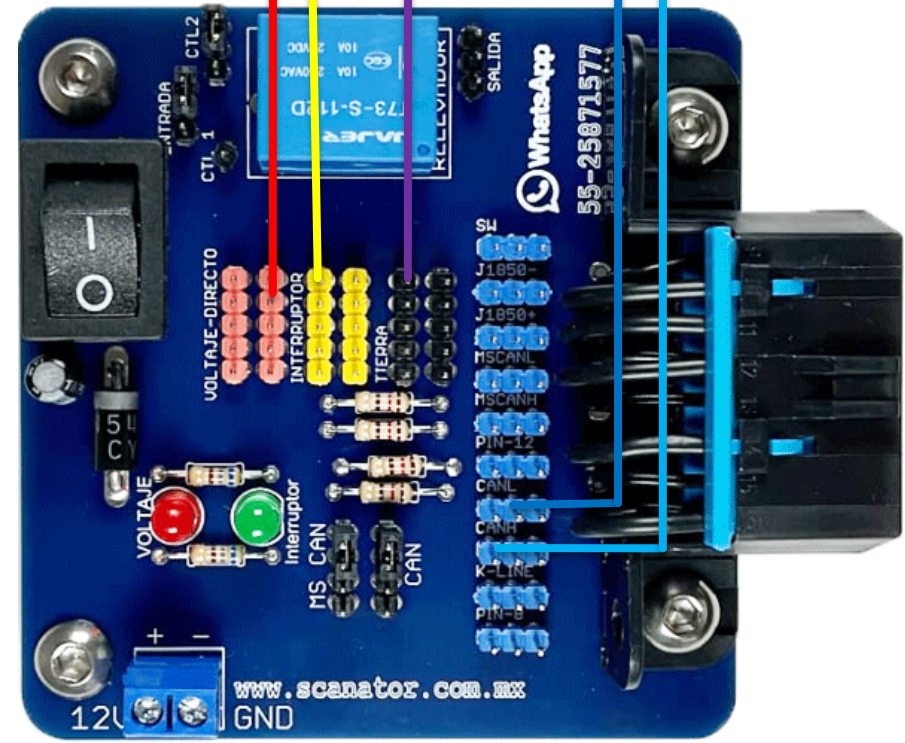
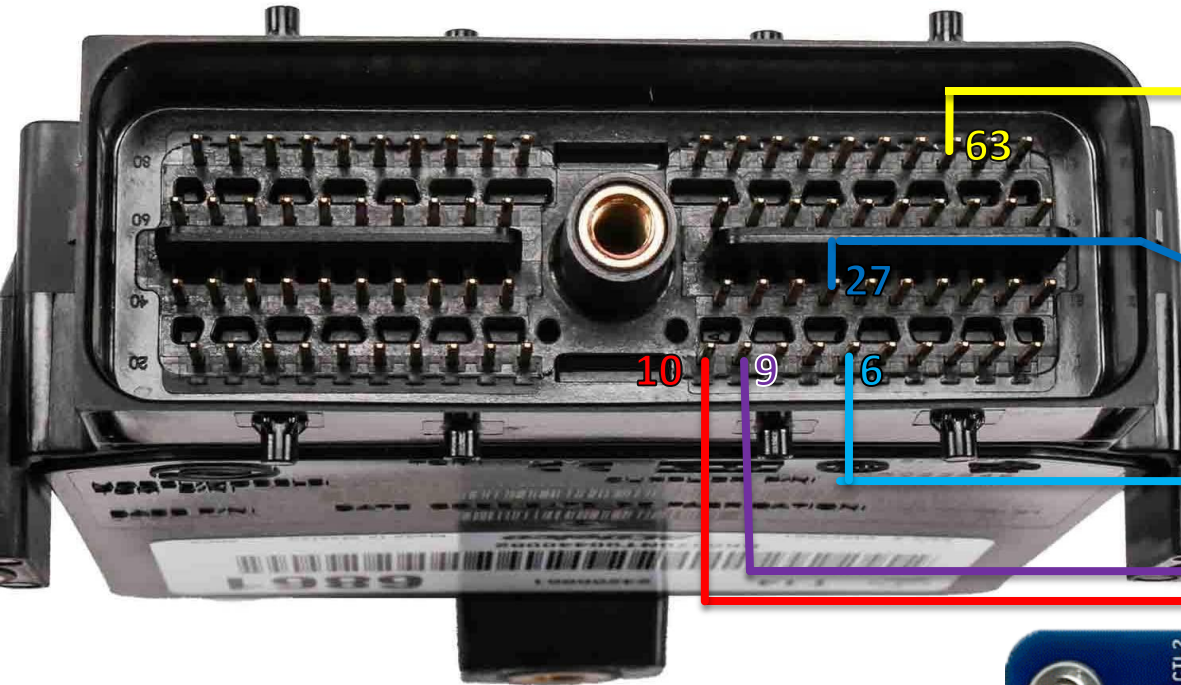

[Regresar al menú](#)

www.scanator.com.mx/alimentadora

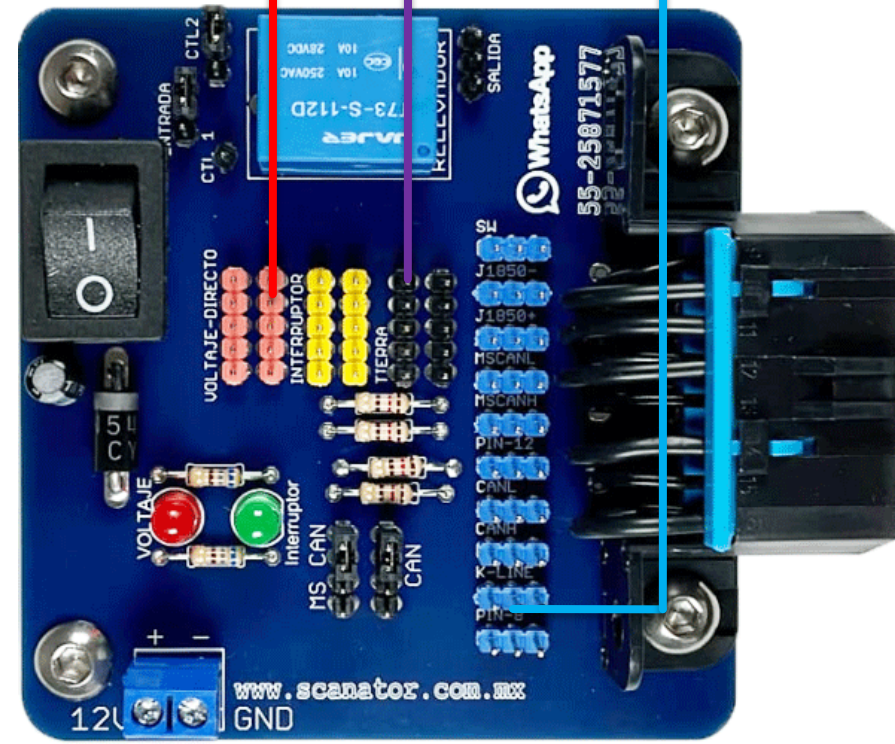
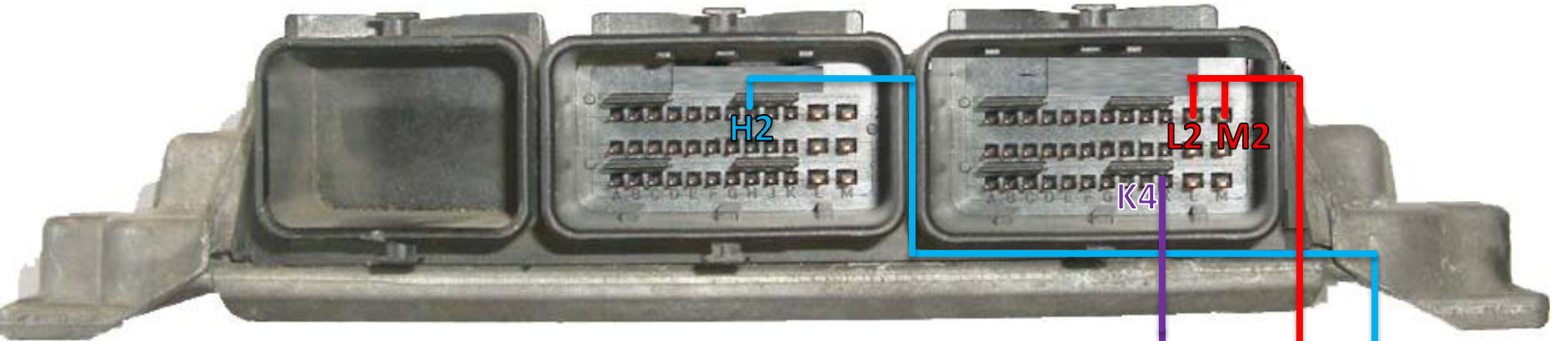

[Regresar al menú](#)

www.scanator.com.mx/alimentadora

Bosch DCU17PC42 irom TC1724 egpt (Mercedes, Opel y Renault)

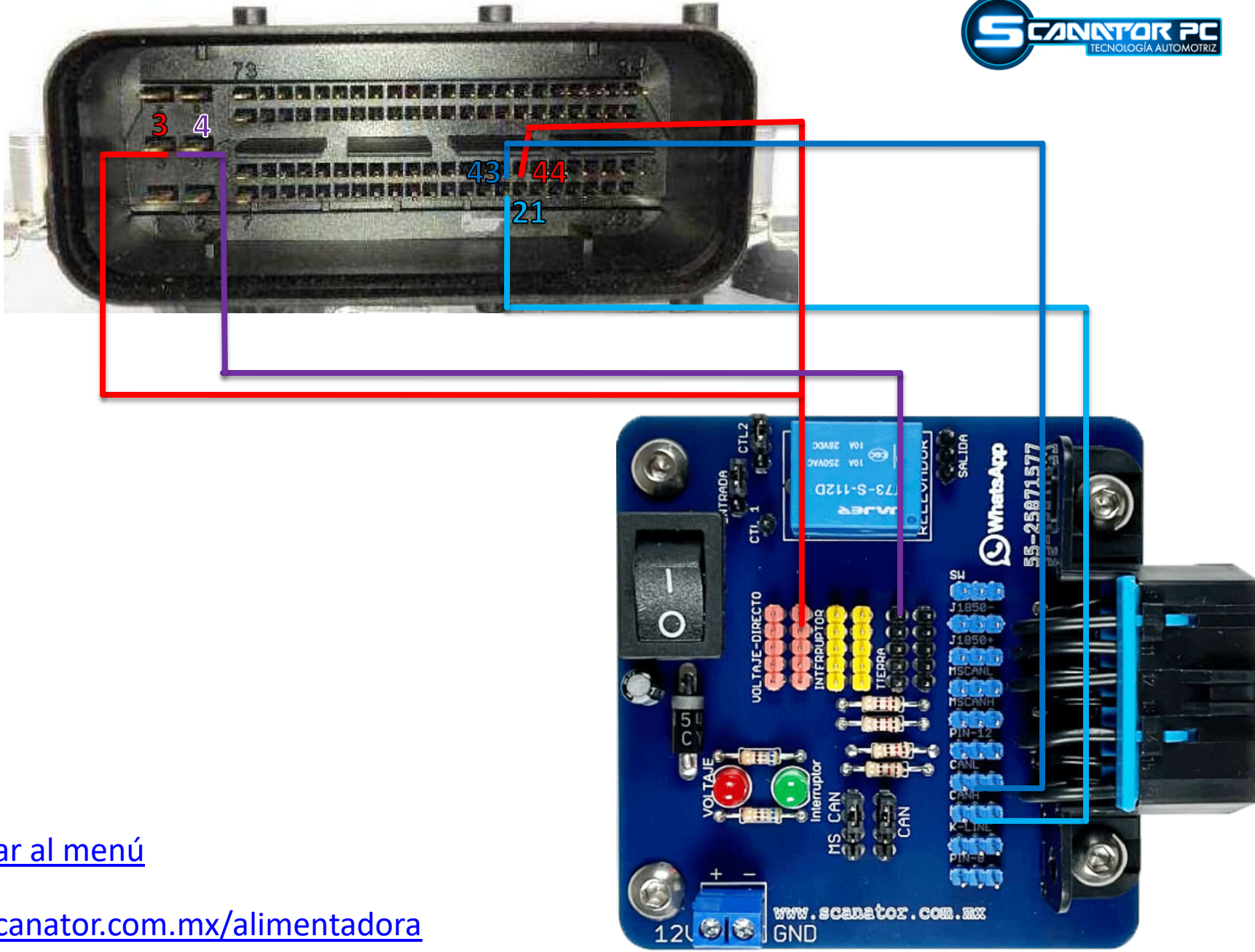

[Regresar al menú](#)

www.scanator.com.mx/alimentadora

12V GND www.scanator.com.mx

Bosch DCU17PC43 irom TC1724 egpt Hyundai

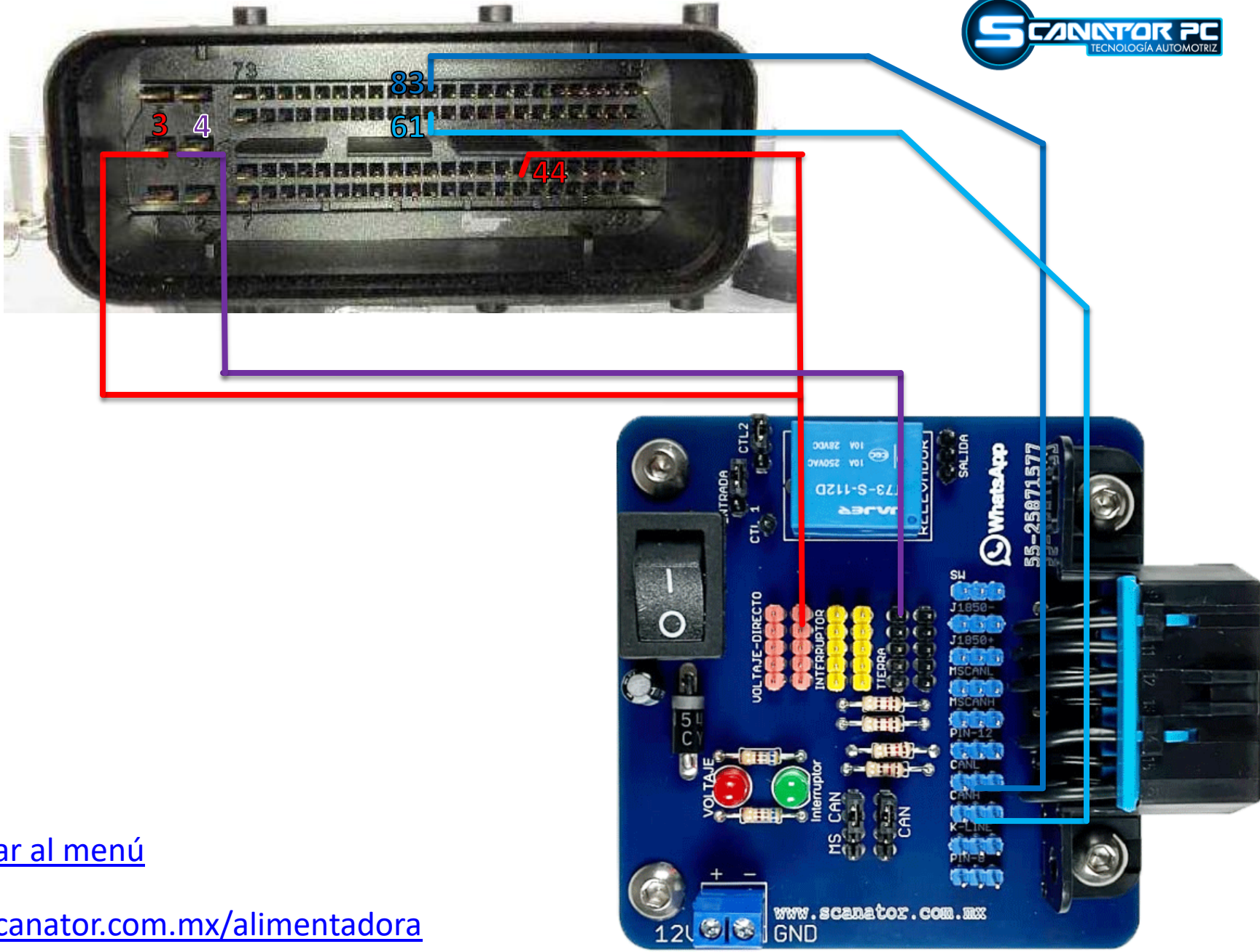

[Regresar al menú](#)

www.scanator.com.mx/alimentadora

Bosch E86 irom TC1797
Chevrolet GMC



[Regresar al menú](#)

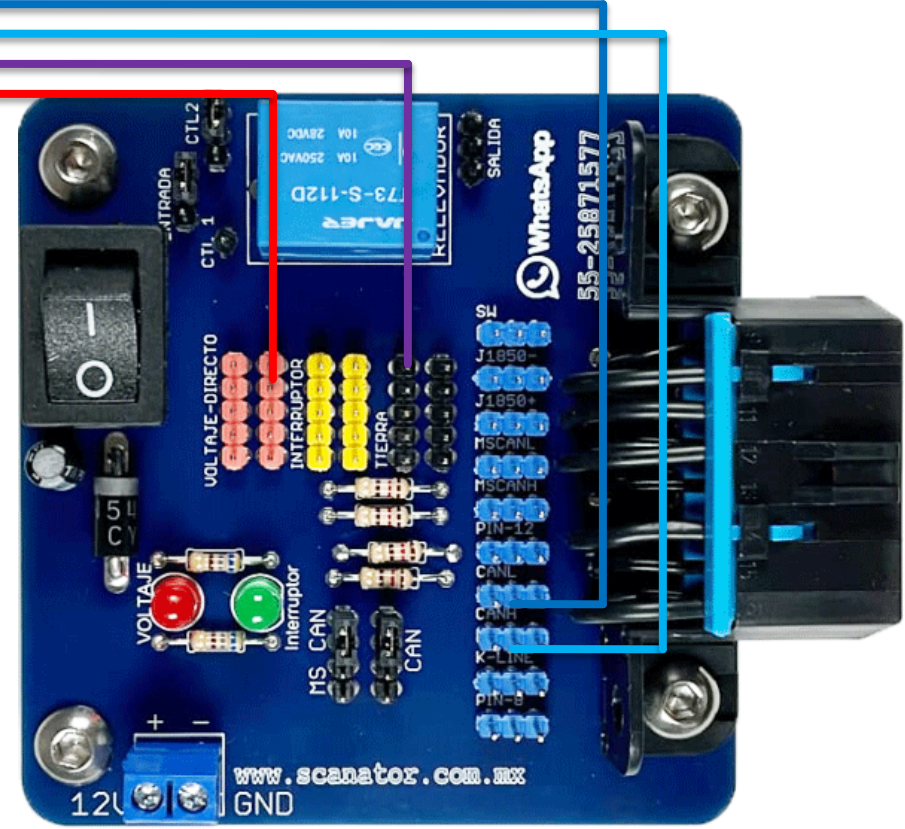
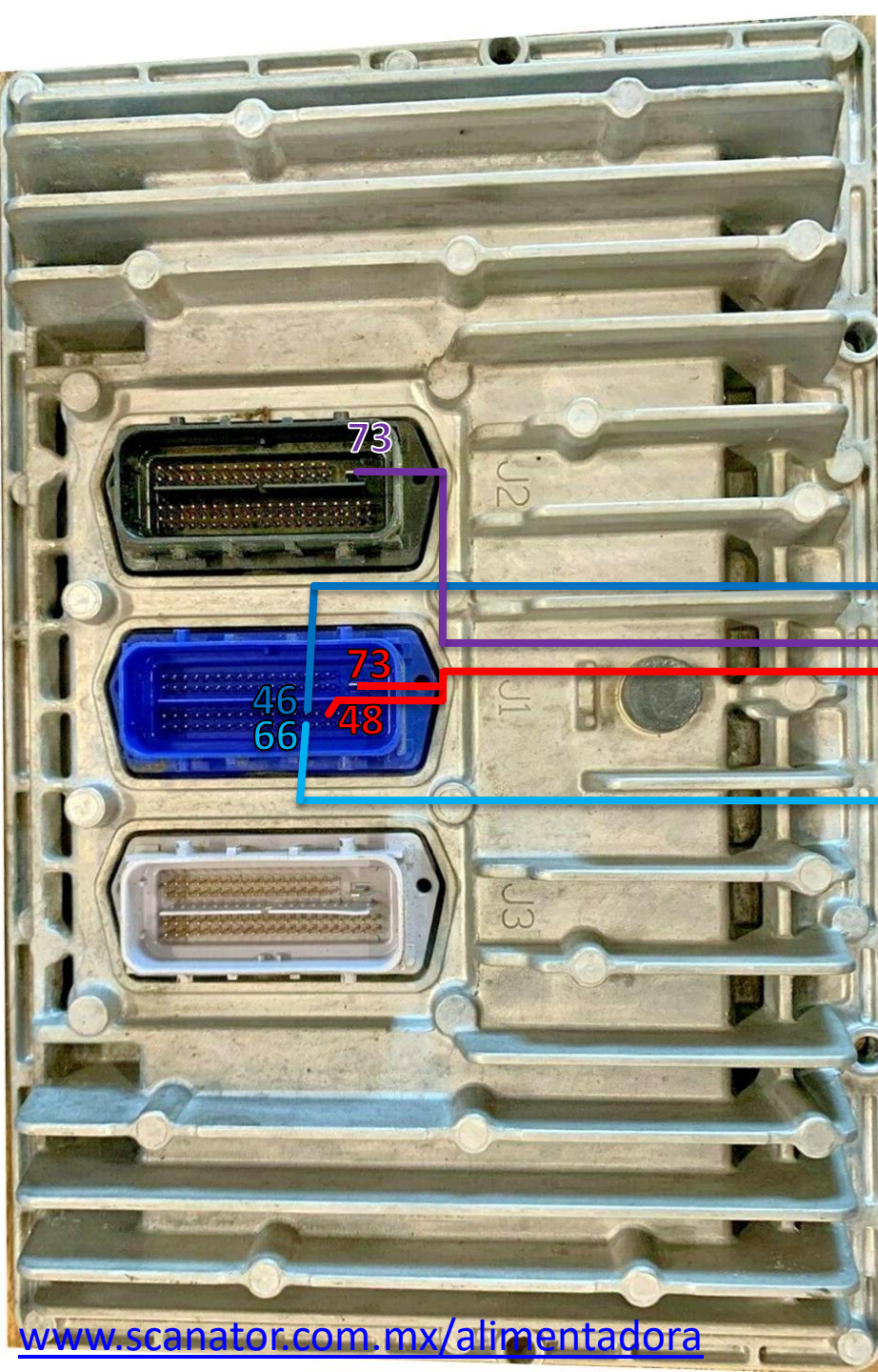

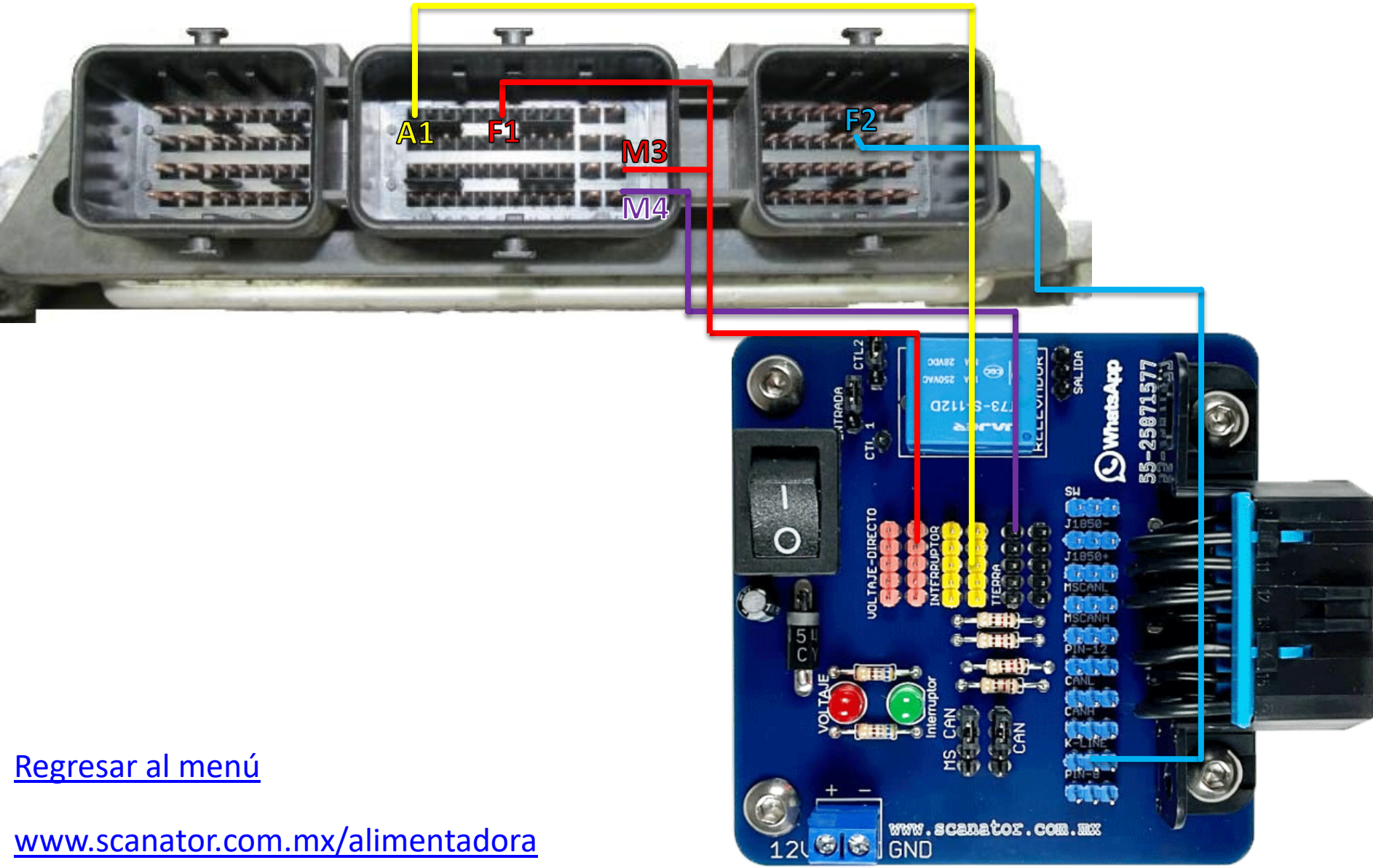

[Regresar al menú](#)

www.scanator.com.mx/alimentadora

Bosch EDC15C2 C167 / EDC15C5
Chrysler

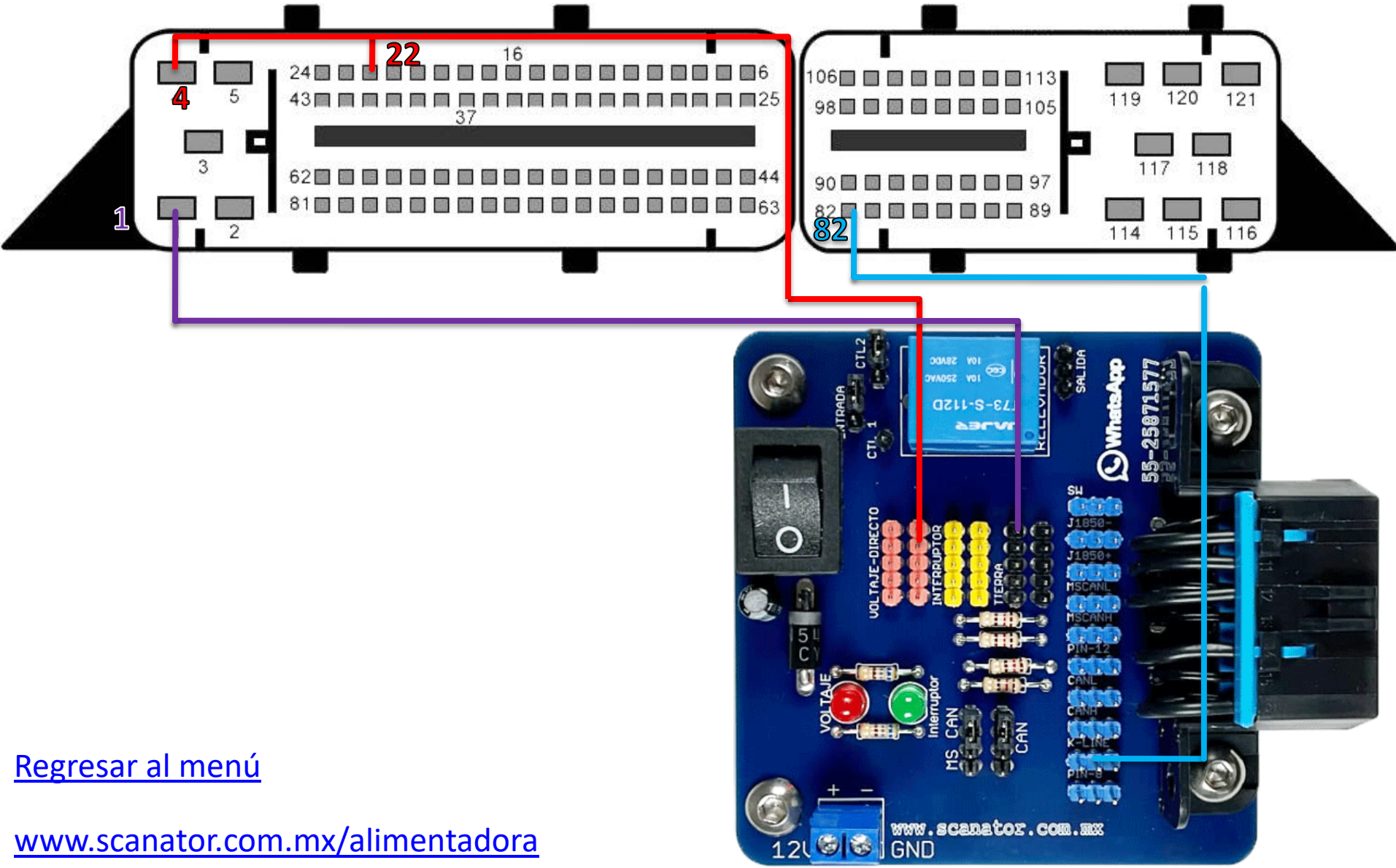

[Regresar al menú](#)

www.scanator.com.mx/alimentadora

Bosch EDC15 serie 1 Peugeot

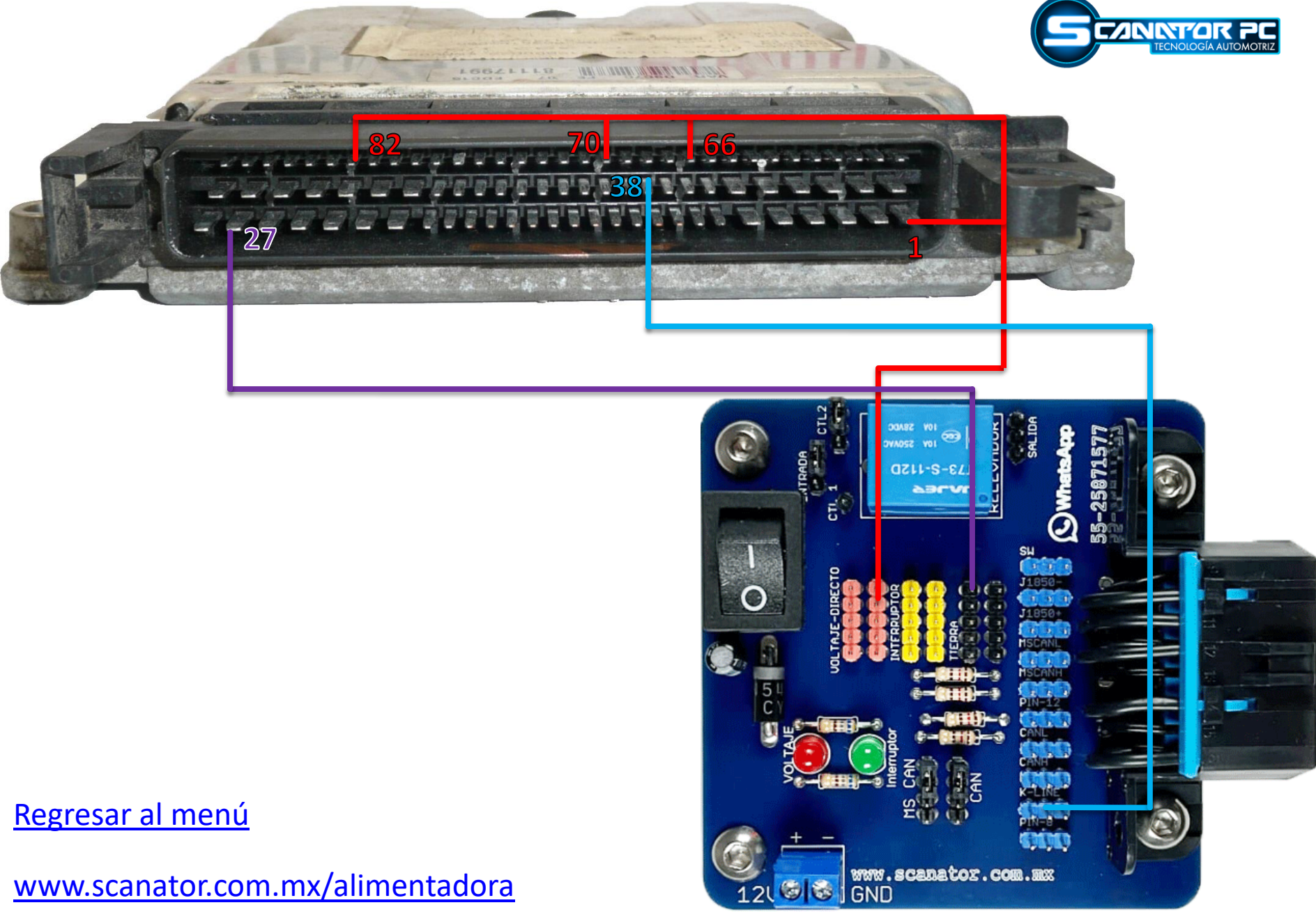

[Regresar al menú](#)

www.scanator.com.mx/alimentadora

12V GND www.scanator.com.mx

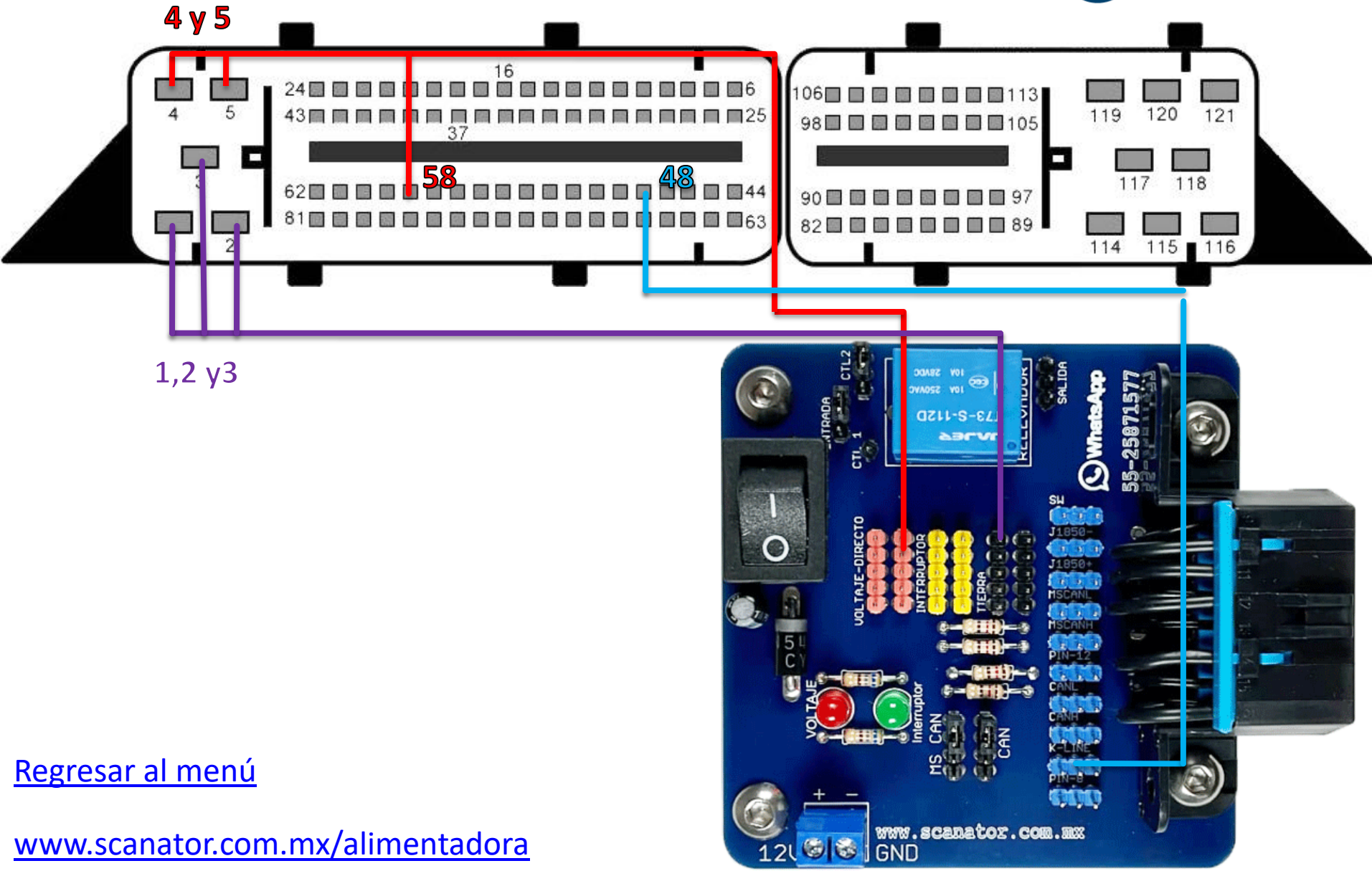

[Regresar al menú](#)

www.scanator.com.mx/alimentadora

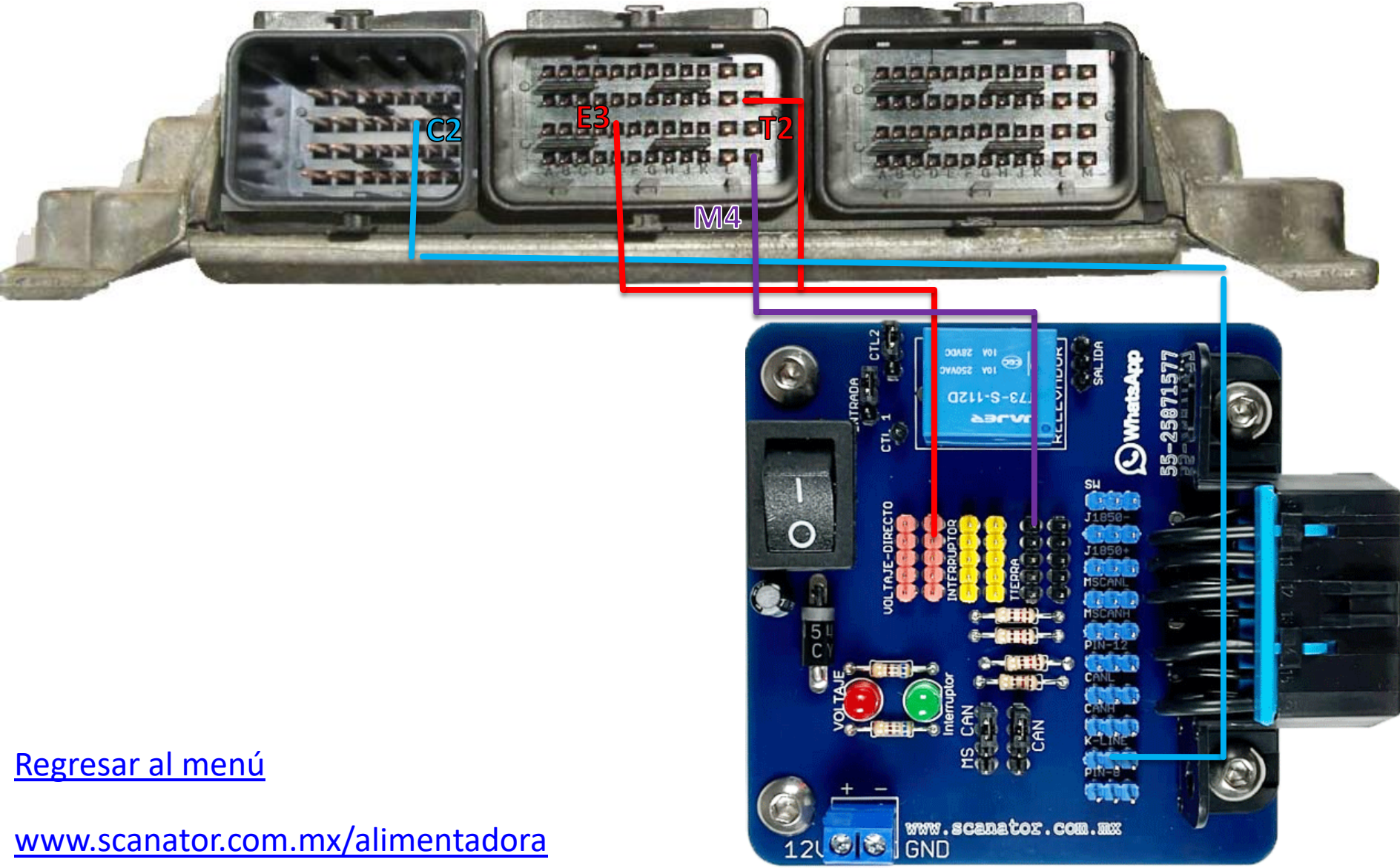

[Regresar al menú](#)

www.scanator.com.mx/alimentadora

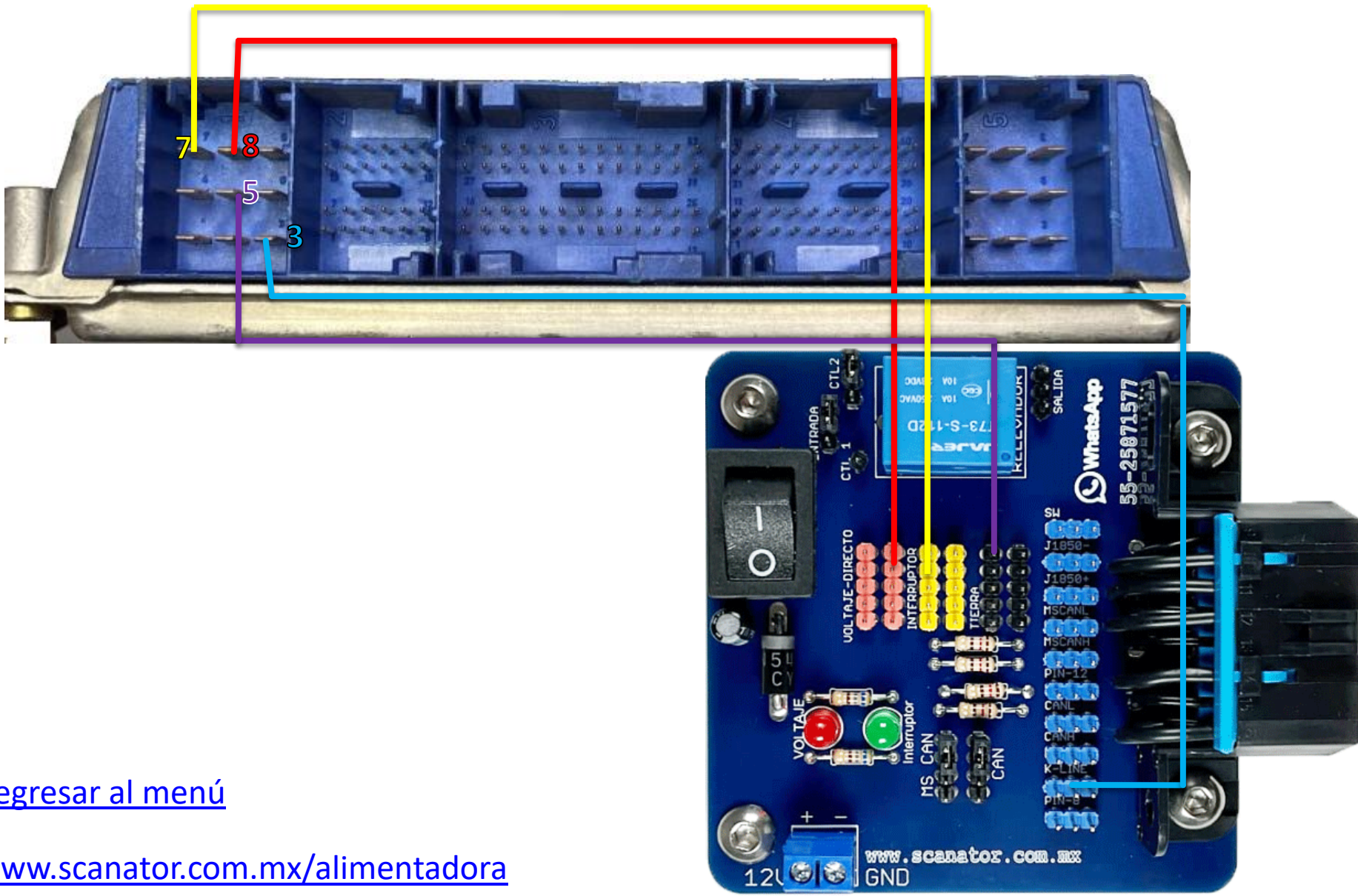

[Regresar al menú](#)

www.scanator.com.mx/alimentadora

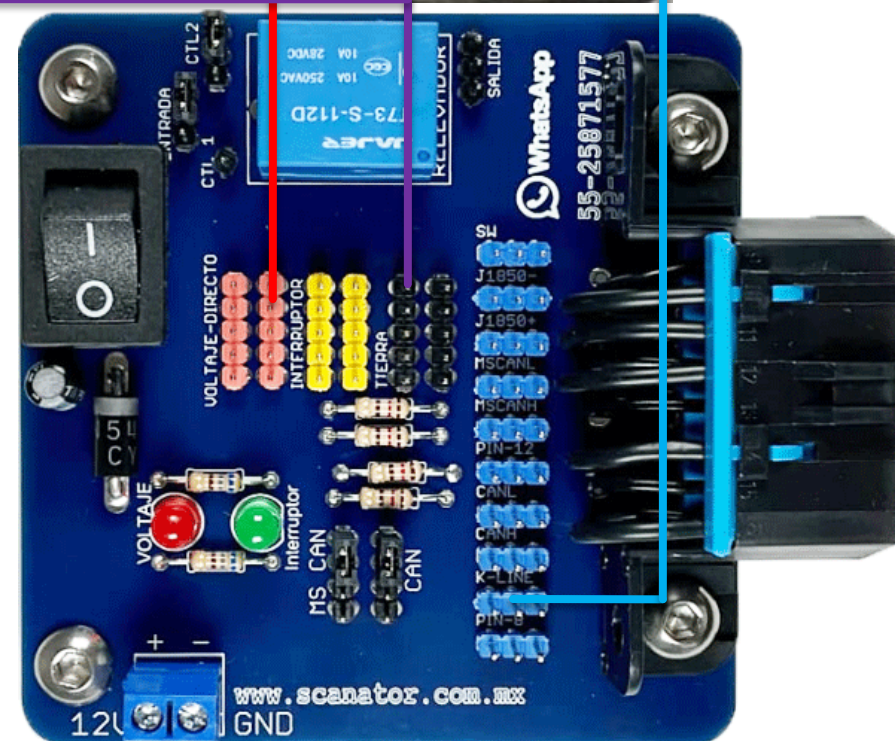
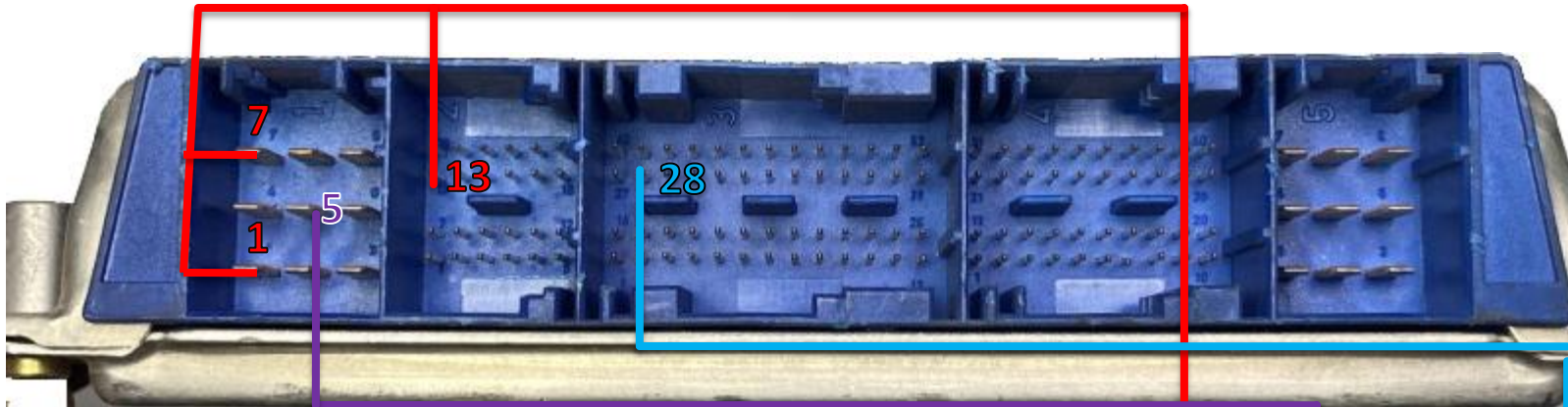

[Regresar al menú](#)

www.scanator.com.mx/alimentadora

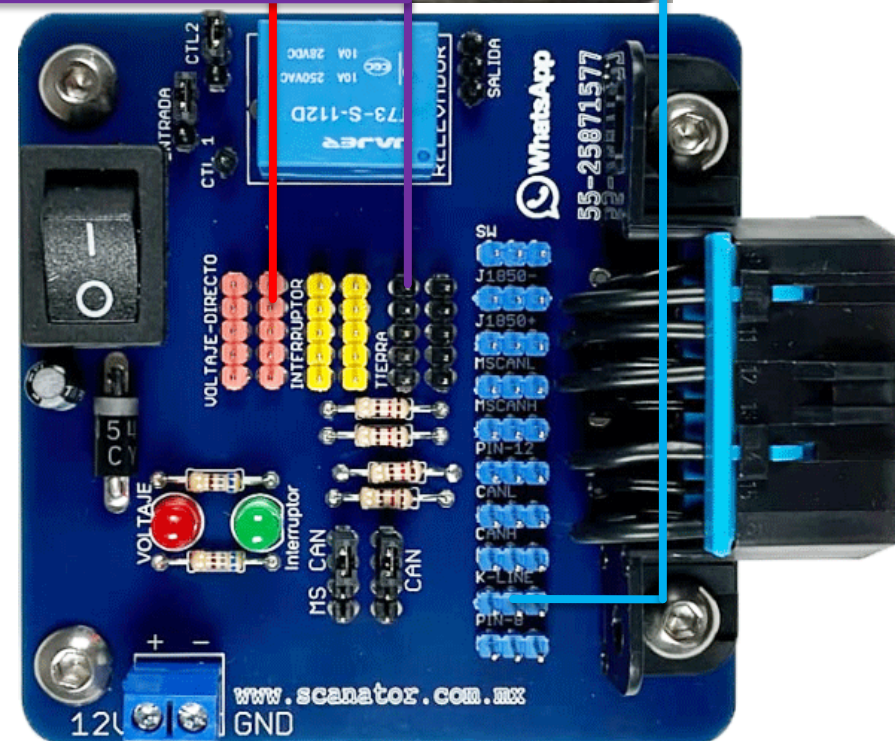
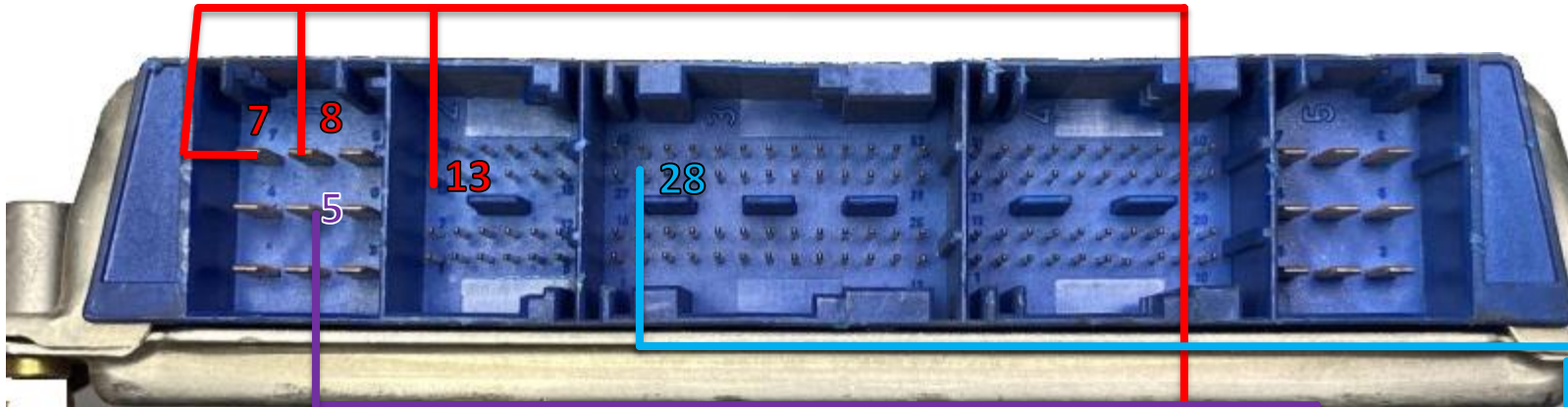

[Regresar al menú](#)

www.scanator.com.mx/alimentadora

Bosch EDC15P+ / EDC15P
EDC15V / EDC15VM+ VAG

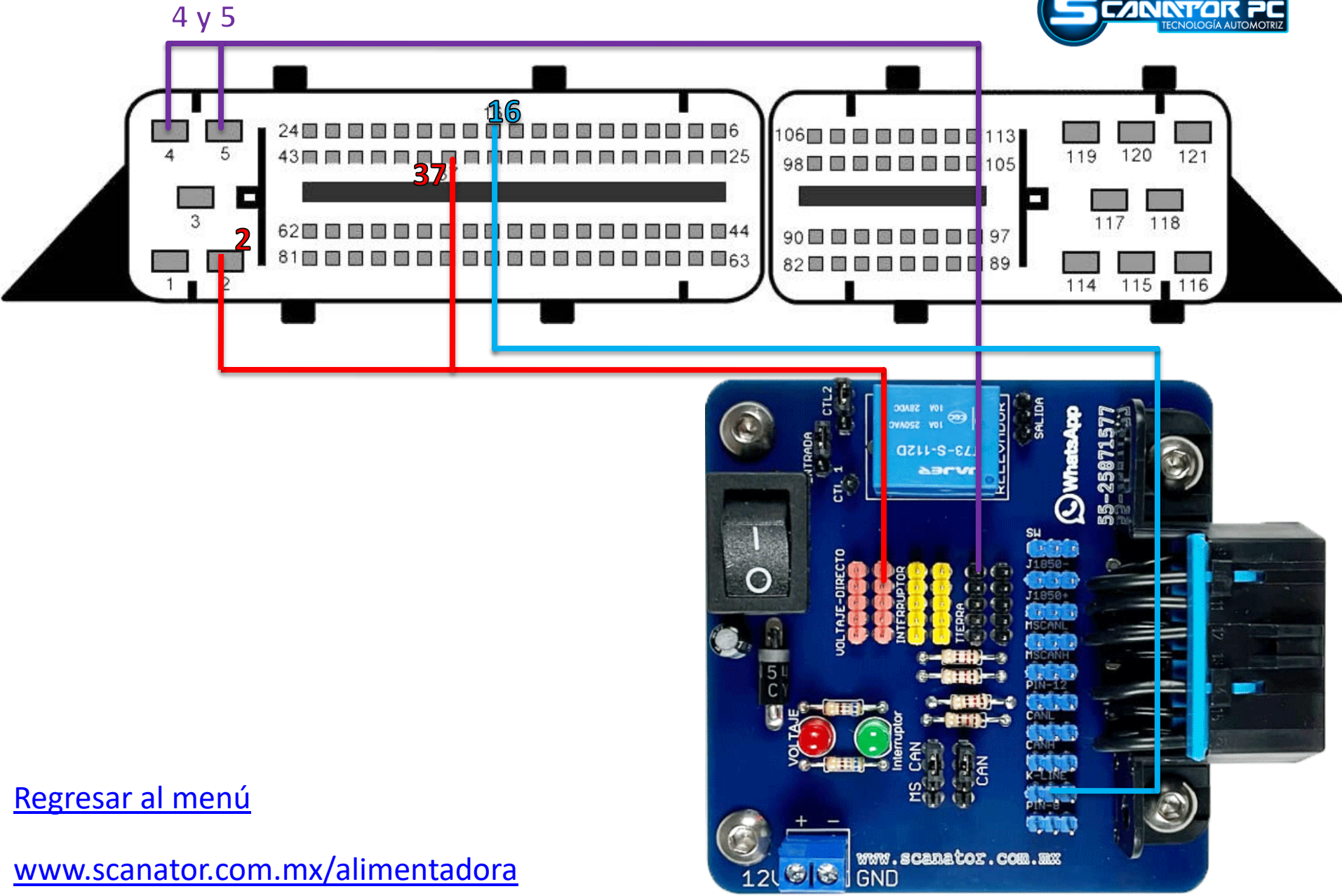

[Regresar al menú](#)

www.scanator.com.mx/alimentadora

Bosch EDC15P+ / EDC15P
EDC15V / EDC15VM+ VAG

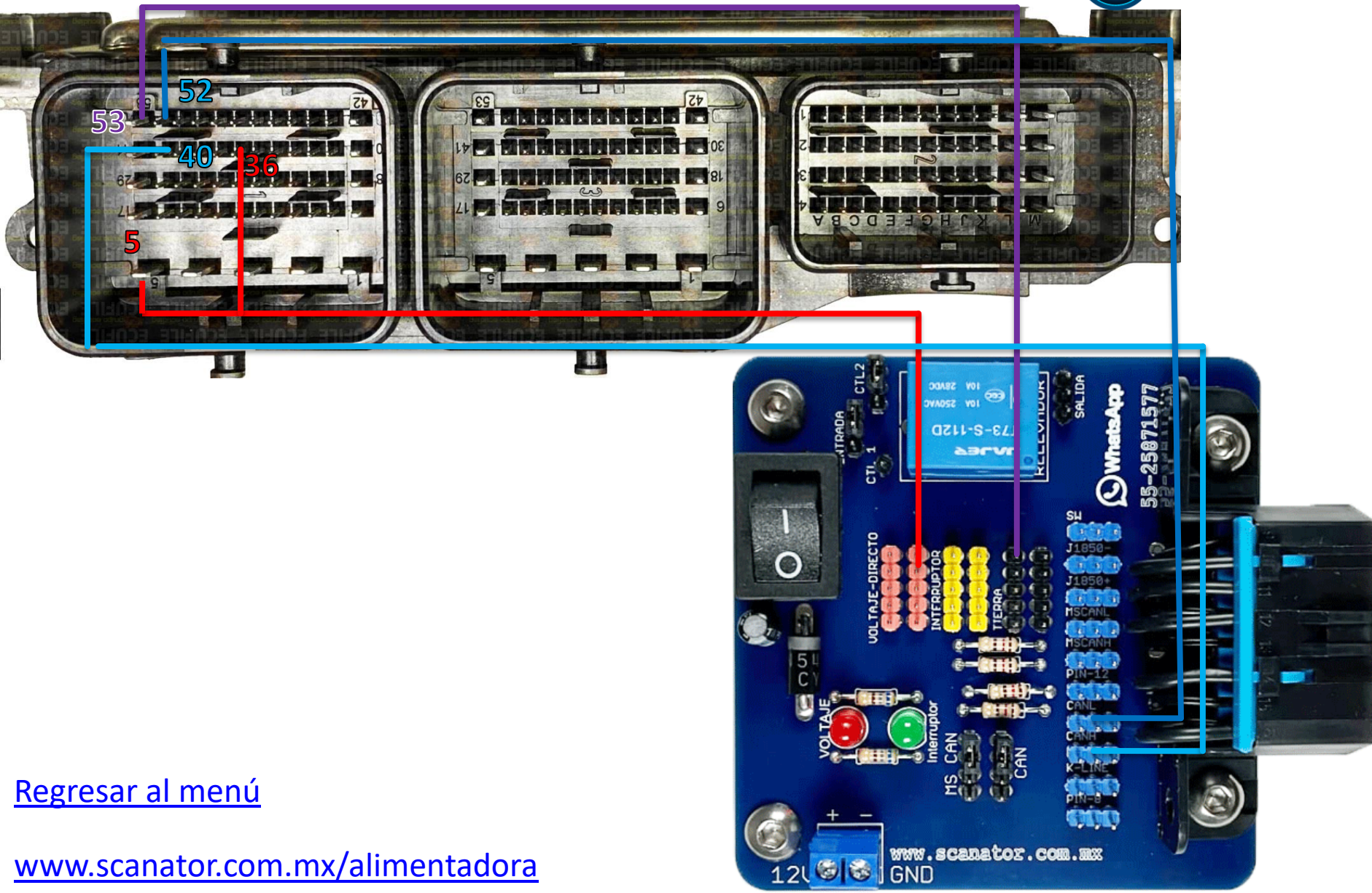

[Regresar al menú](#)

www.scanator.com.mx/alimentadora

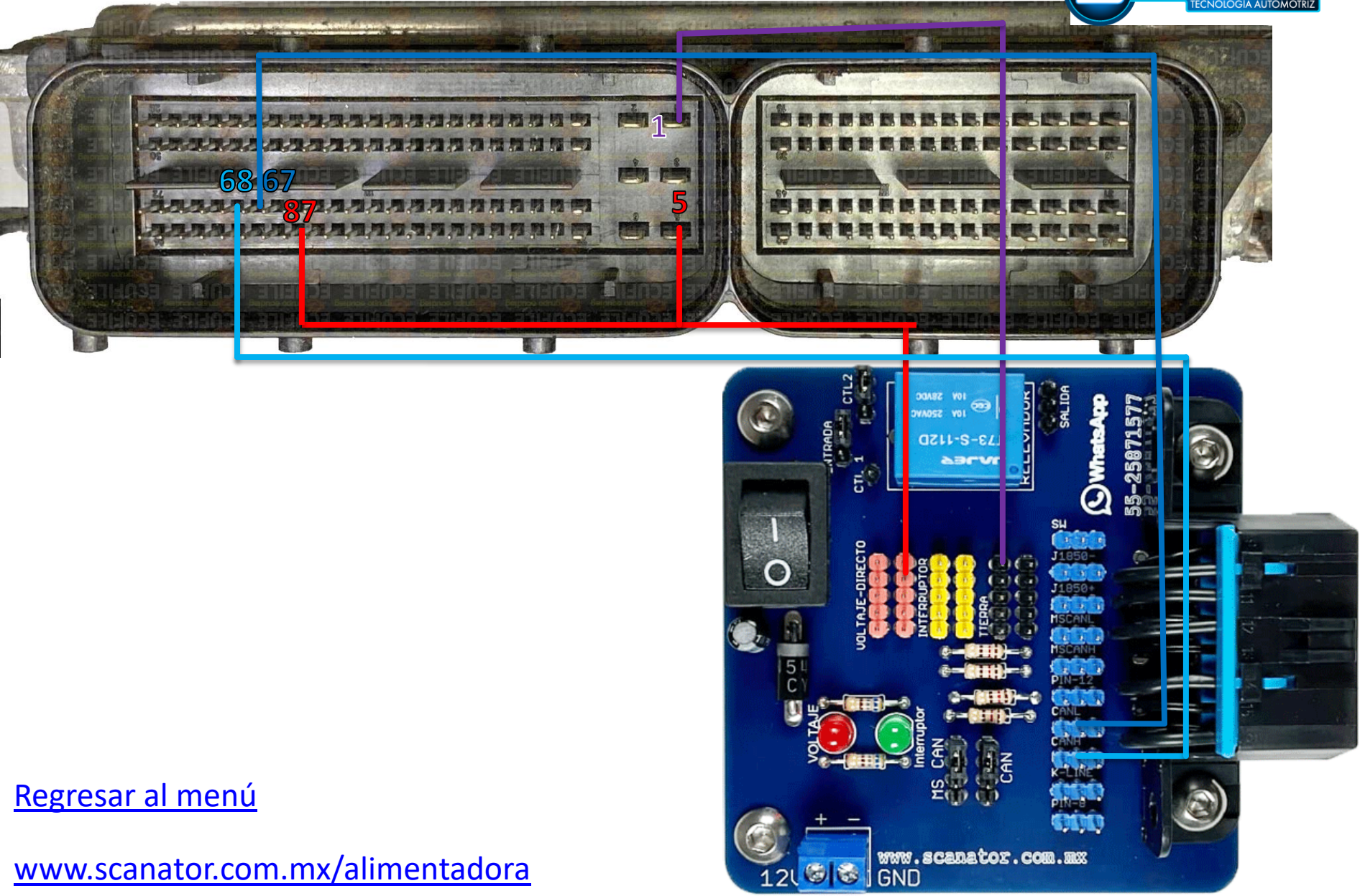

[Regresar al menú](#)

www.scanator.com.mx/alimentadora

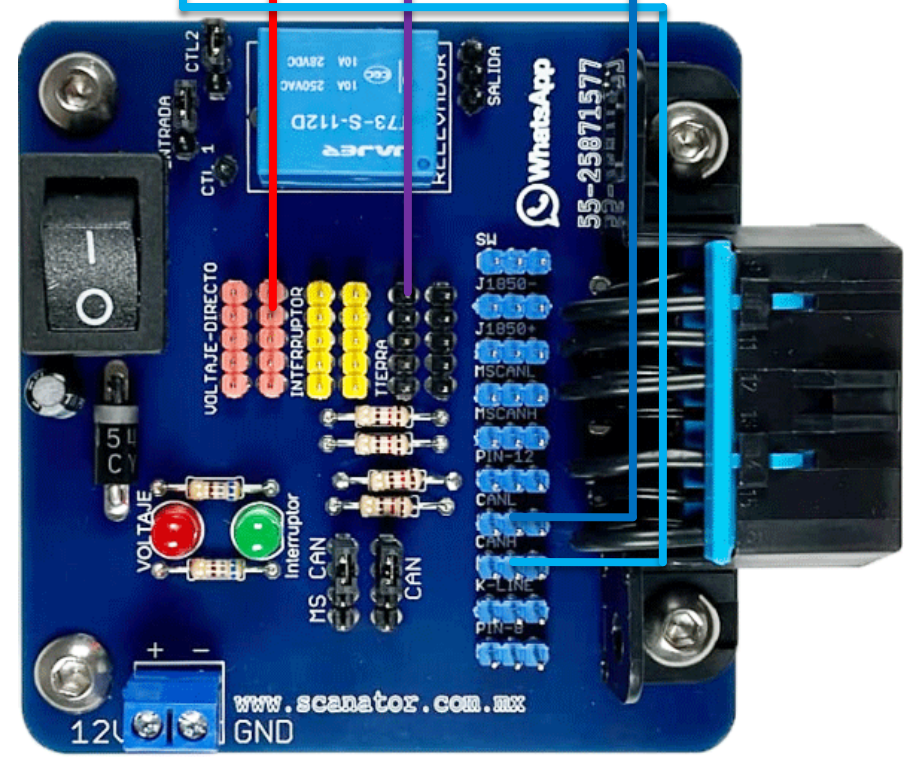
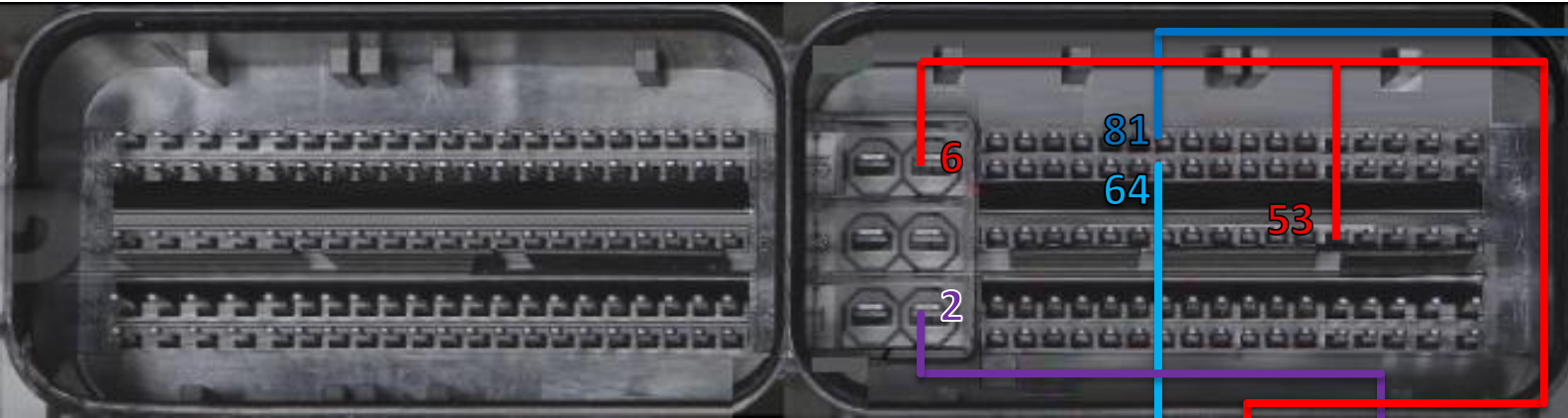

[Regresar al menú](#)

www.scanator.com.mx/alimentadora

Bosch EDC17C58 / TC1793
Honda

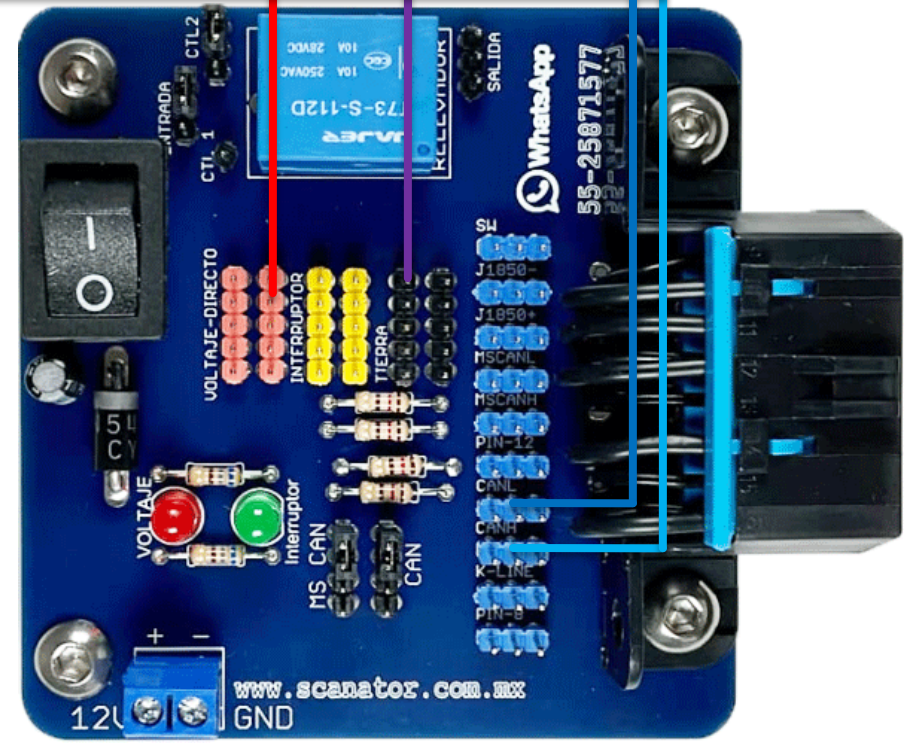
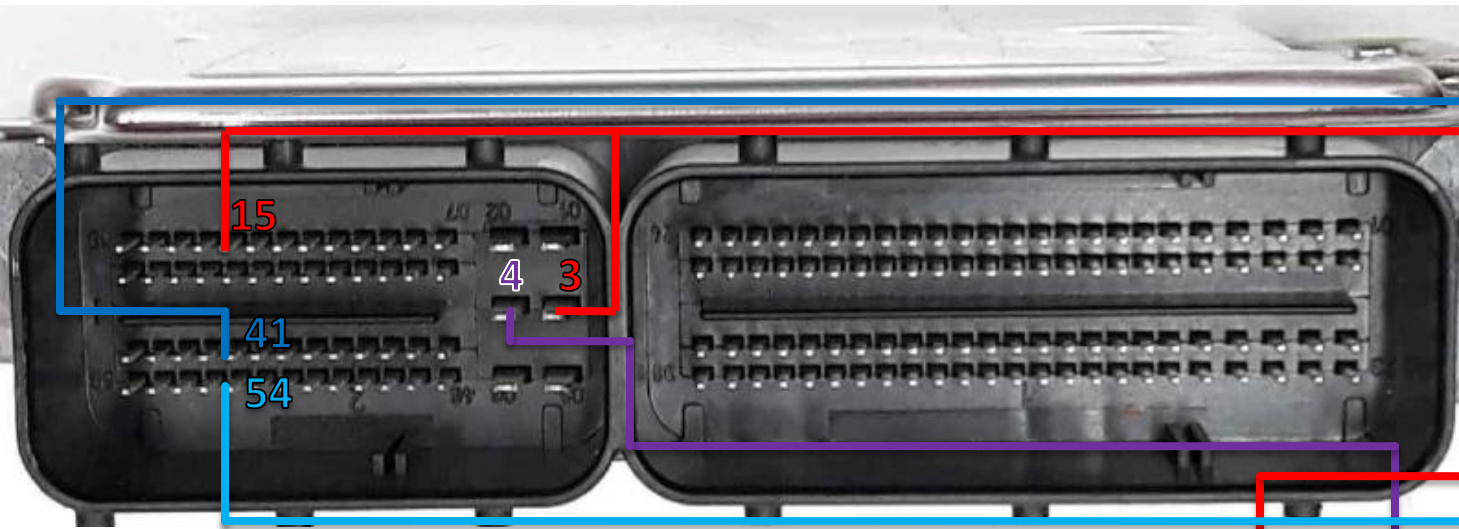

[Regresar al menú](#)

www.scanator.com.mx/alimentadora

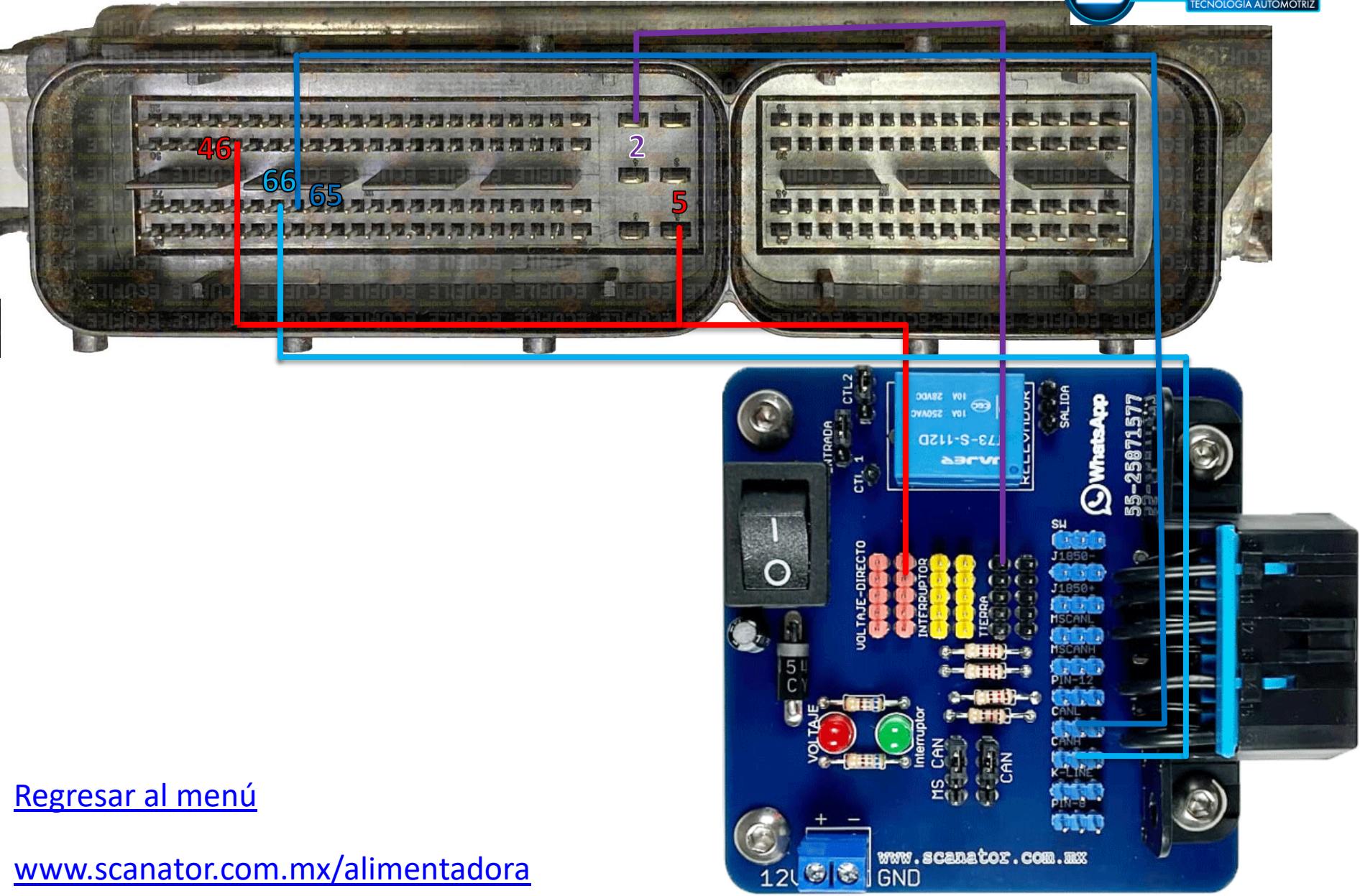

[Regresar al menú](#)

www.scanator.com.mx/alimentadora

Bosch EDC17C66 / TC1793
Mercedes

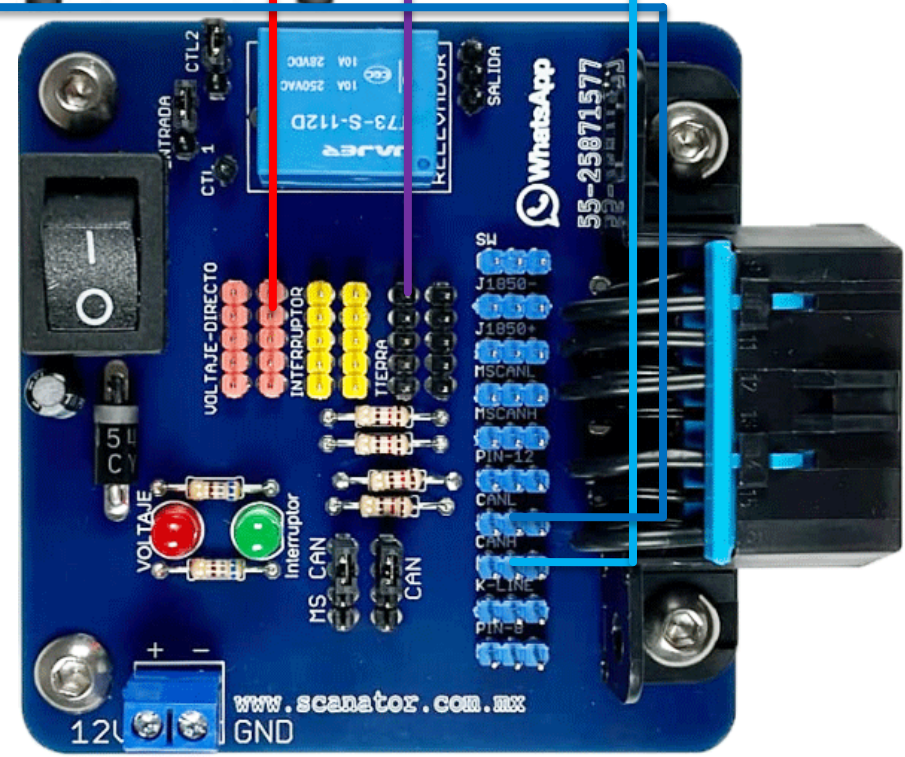
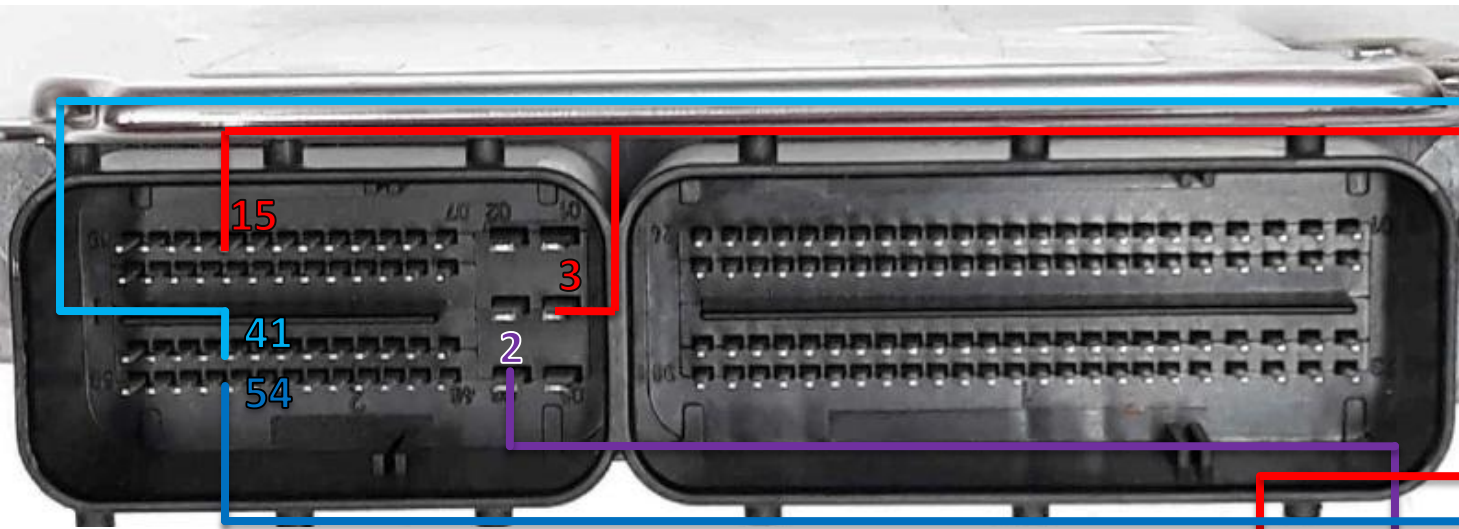

[Regresar al menú](#)

www.scanator.com.mx/alimentadora

Bosch EDC17C66 / TC1793

Bosch EDC17C70 / TC1793 Ford

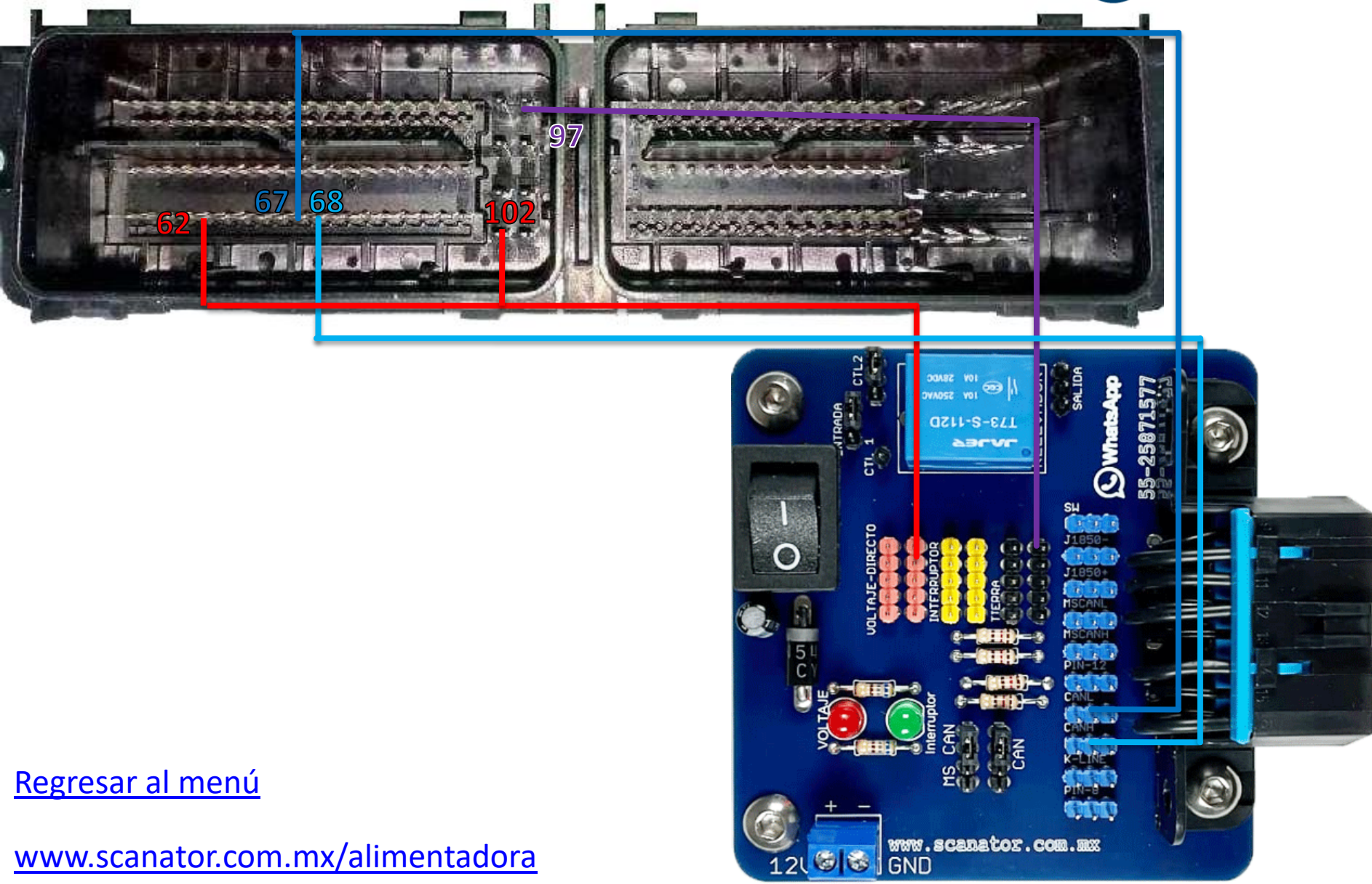

[Regresar al menú](#)

www.scanator.com.mx/alimentadora

Bosch EDC17C74 / TC1793 VAG Tipo 1

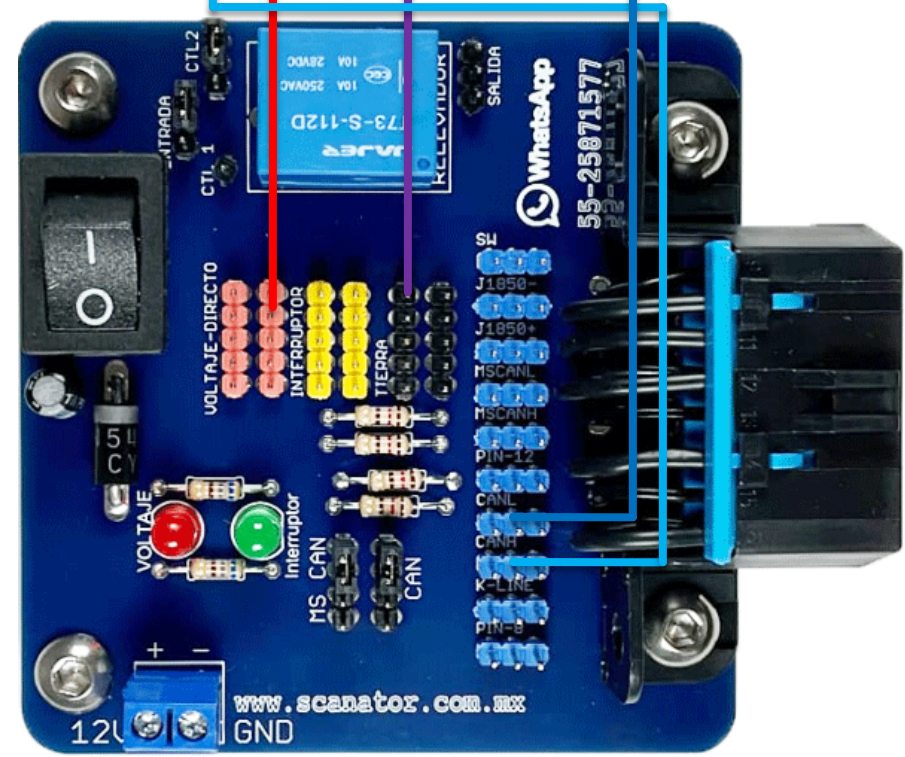
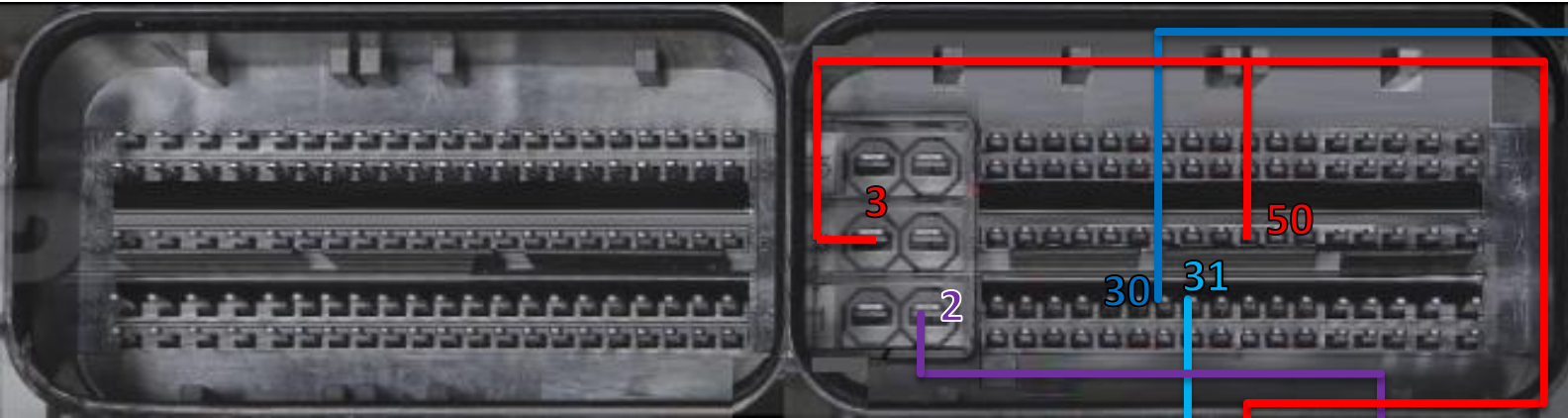

[Regresar al menú](#)

www.scanator.com.mx/alimentadora

Bosch EDC17C74 / TC1793 VAG Tipo 2

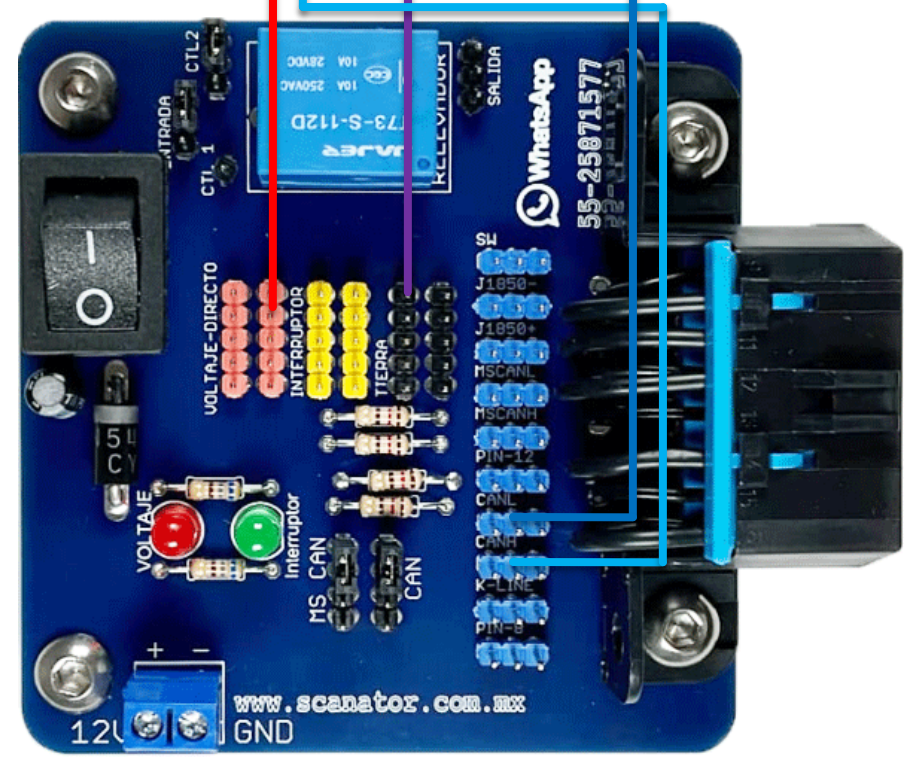
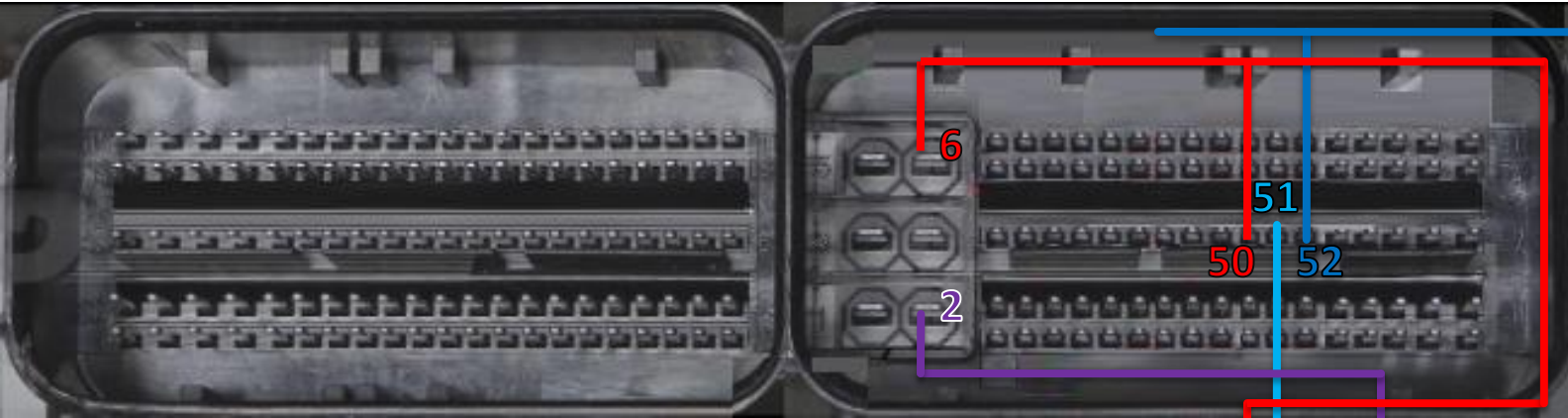

[Regresar al menú](#)

www.scanator.com.mx/alimentadora

Bosch EDC17C84 / TC1782
Nissan

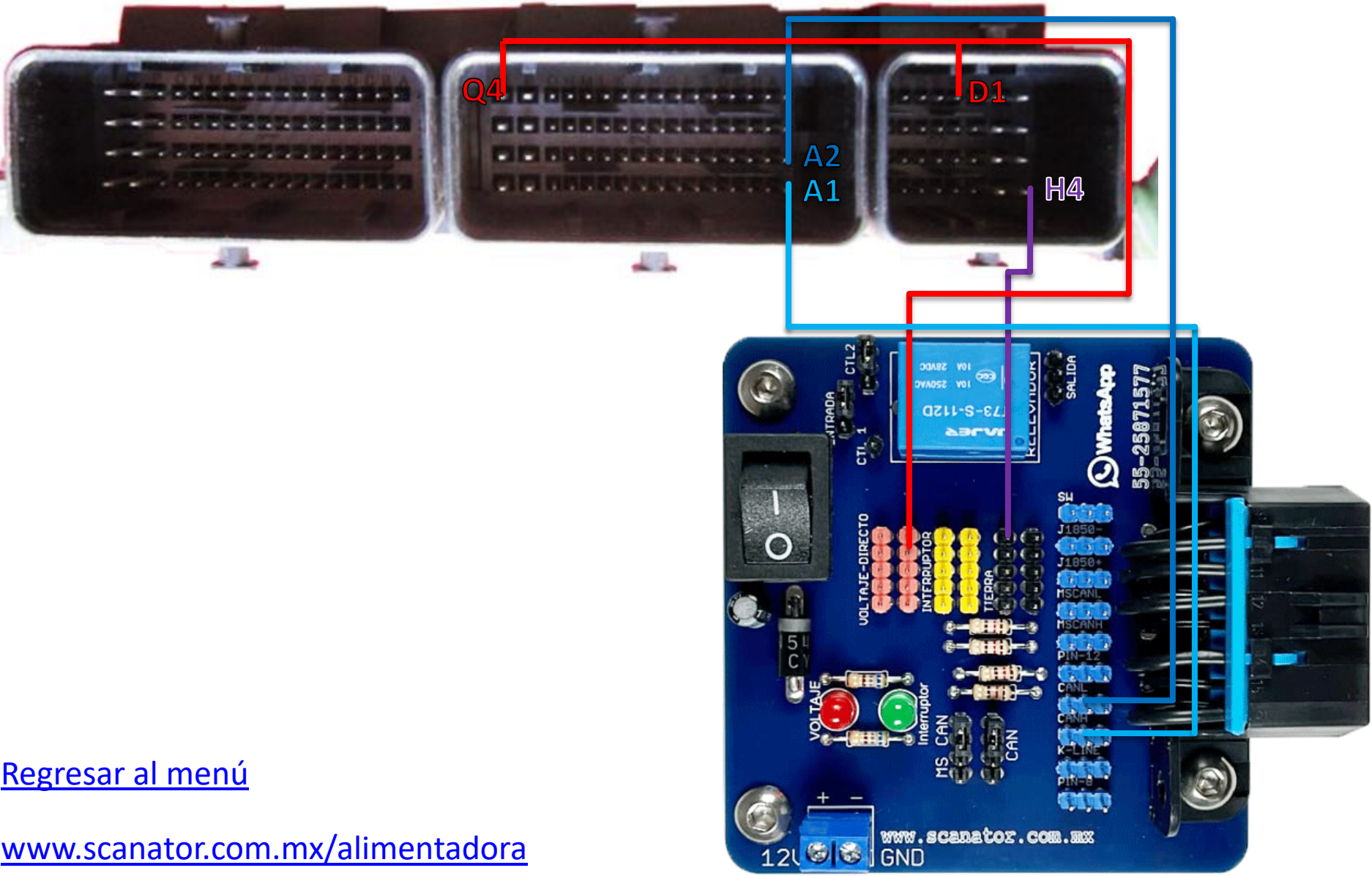

[Regresar al menú](#)

www.scanator.com.mx/alimentadora

www.scanator.com.mx

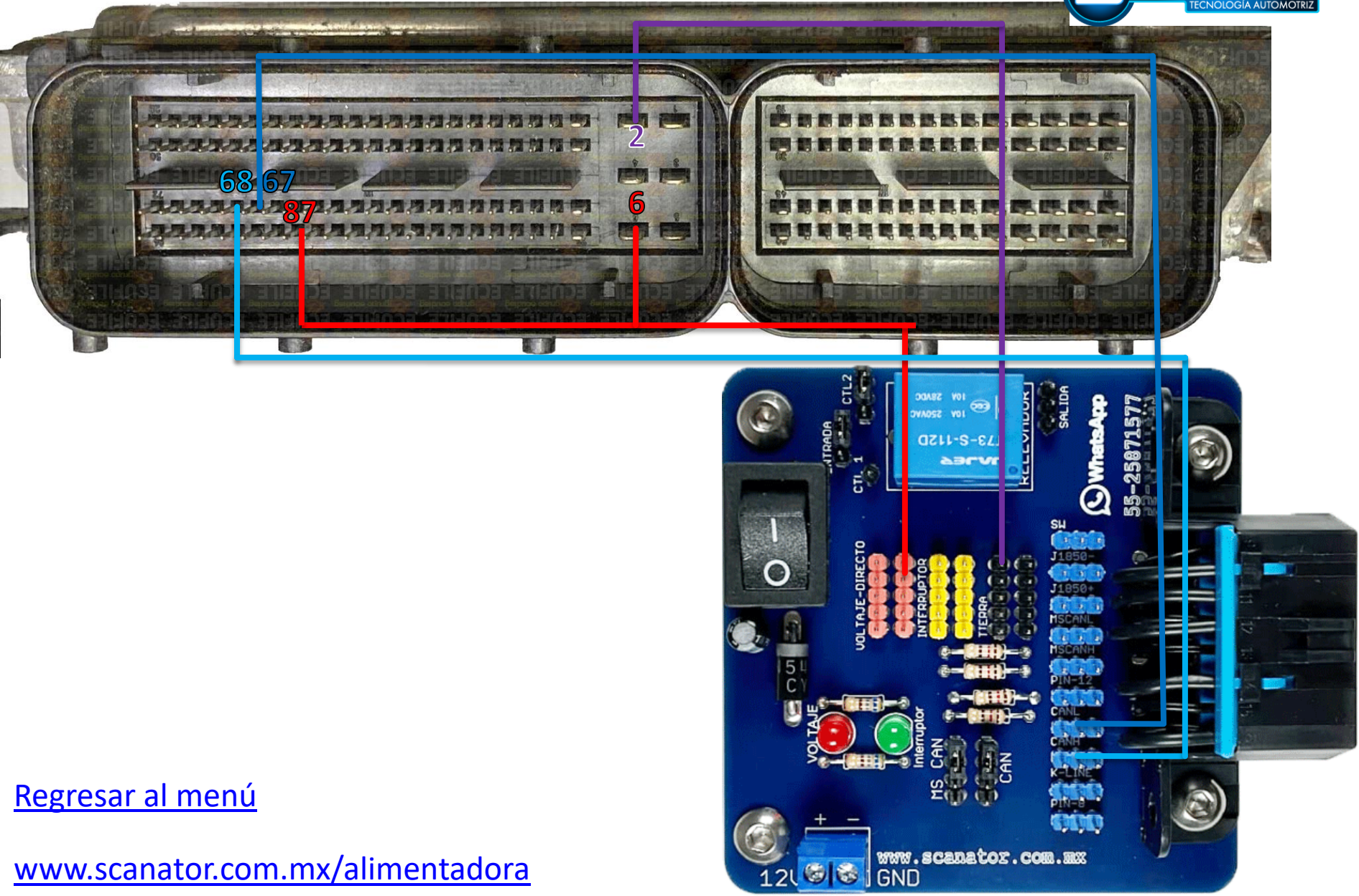

[Regresar al menú](#)

www.scanator.com.mx/alimentadora

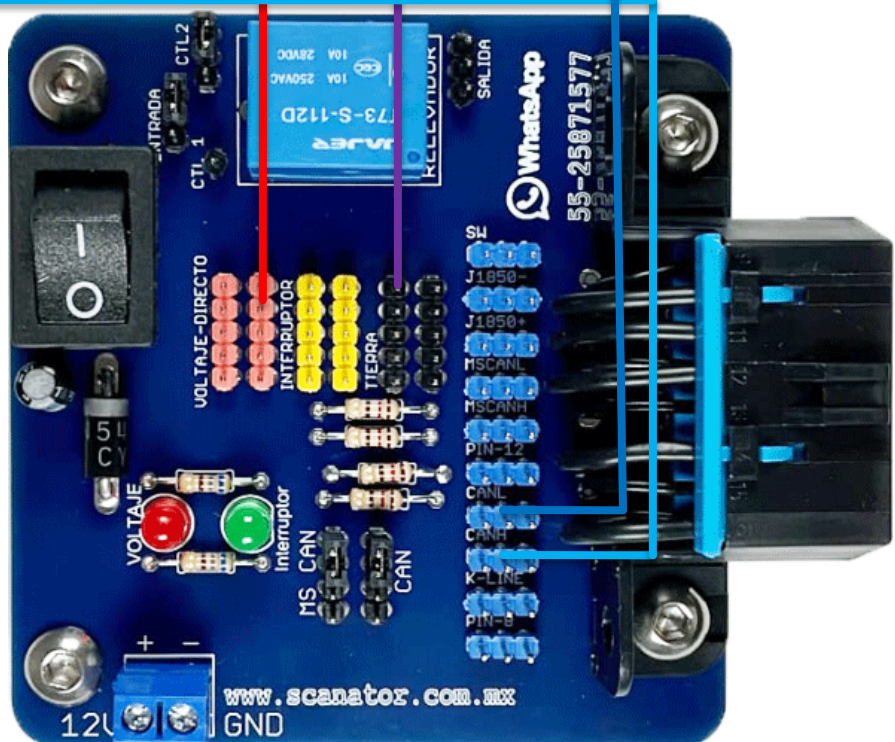

Bosch EDC17CP07 / TC1766
Toyota

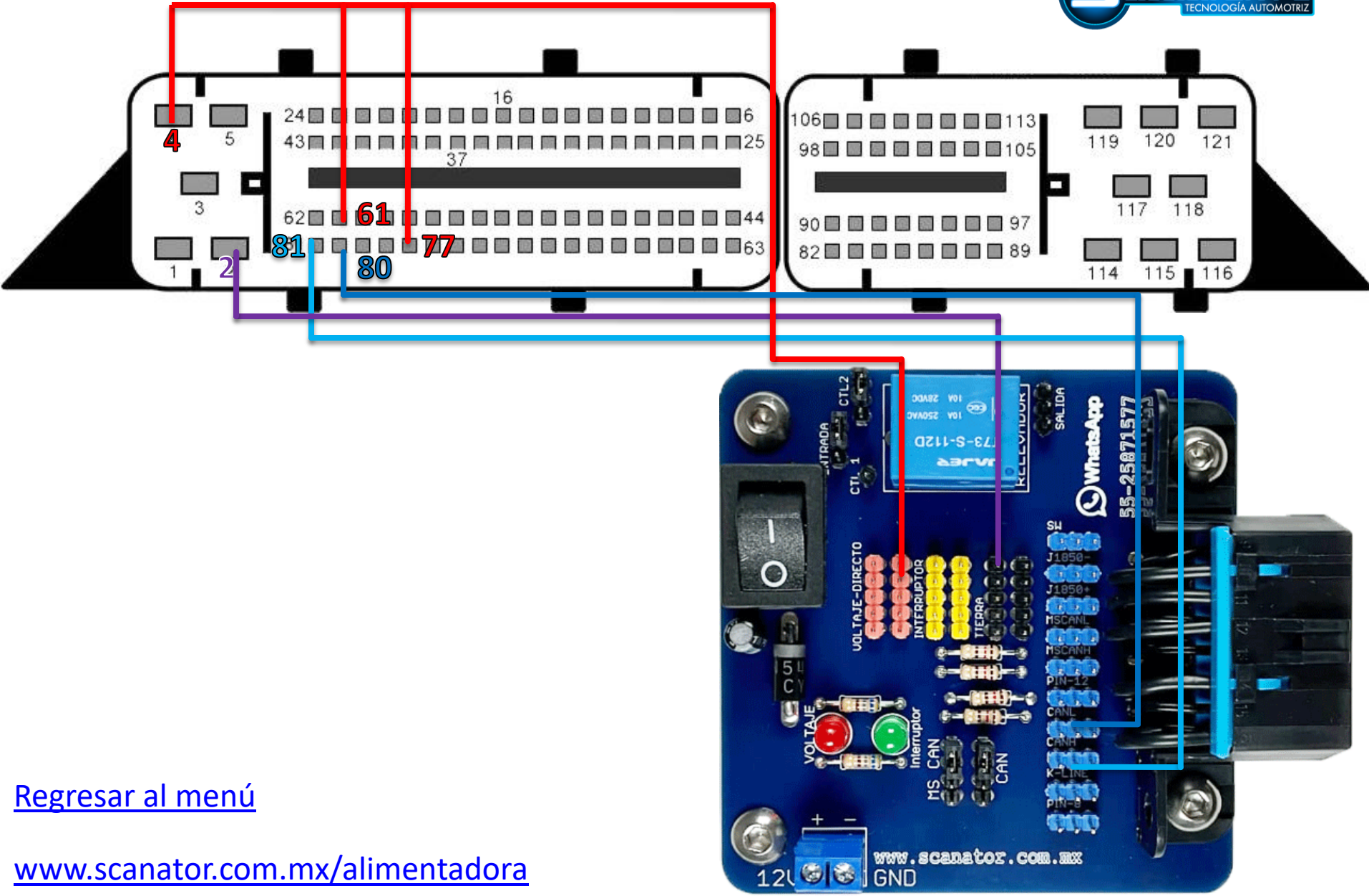

[Regresar al menú](#)

www.scanator.com.mx/alimentadora

Bosch EDC17CP11 / TC1796
Land Rover

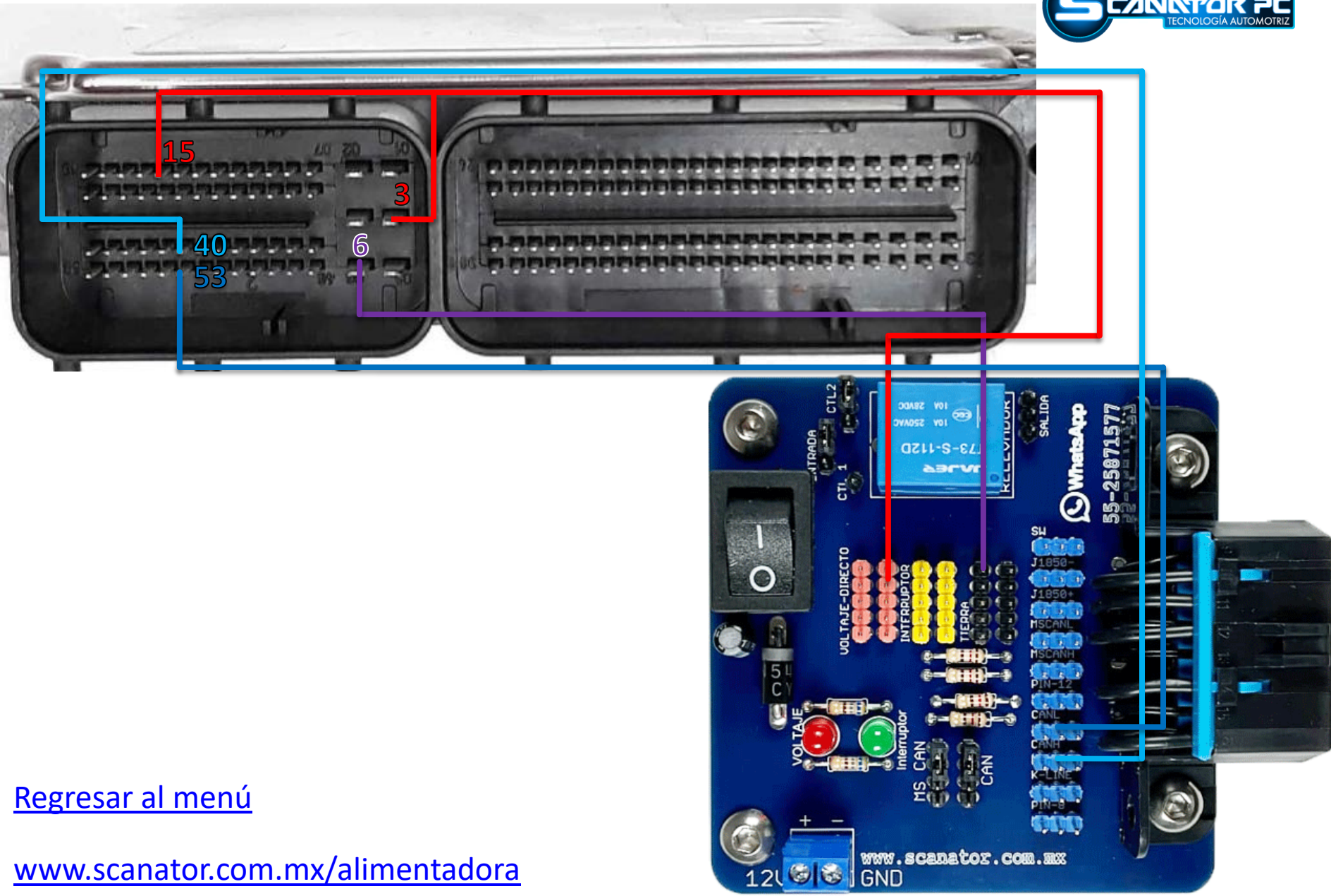

15

3

40

53

6

[Regresar al menú](#)

www.scanator.com.mx/alimentadora

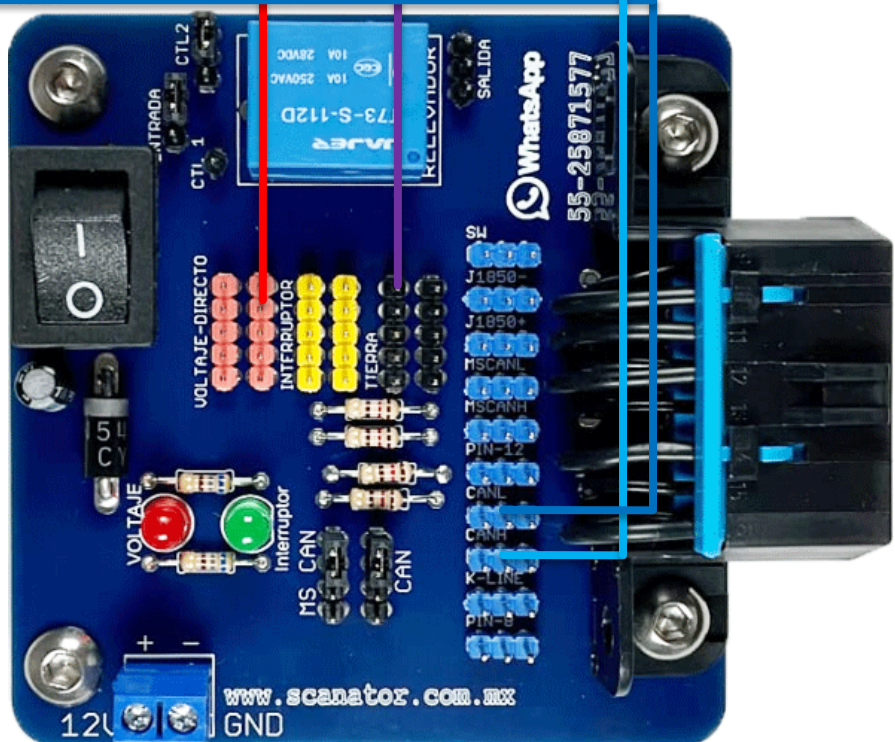

TCM Mazda 3

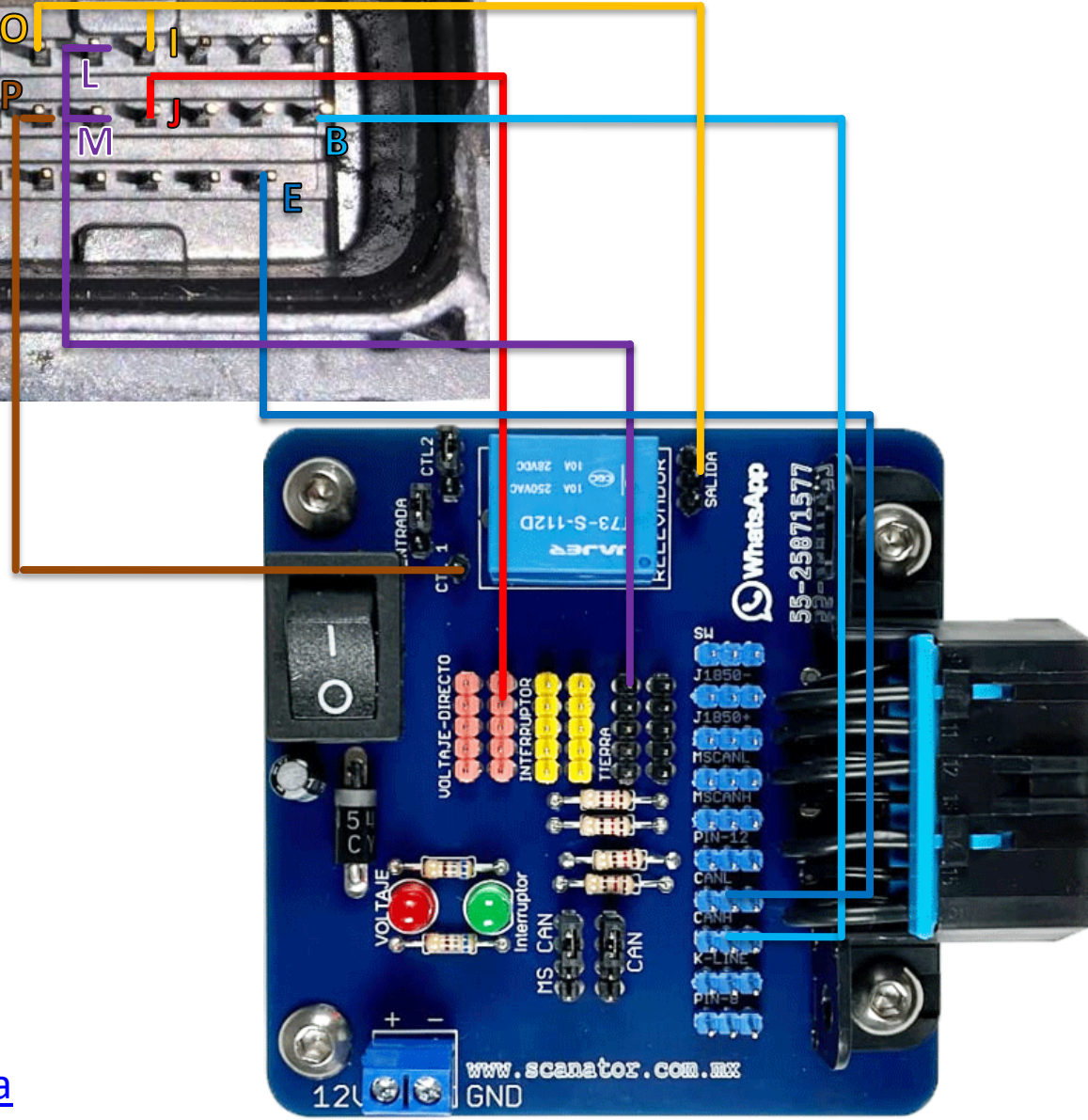
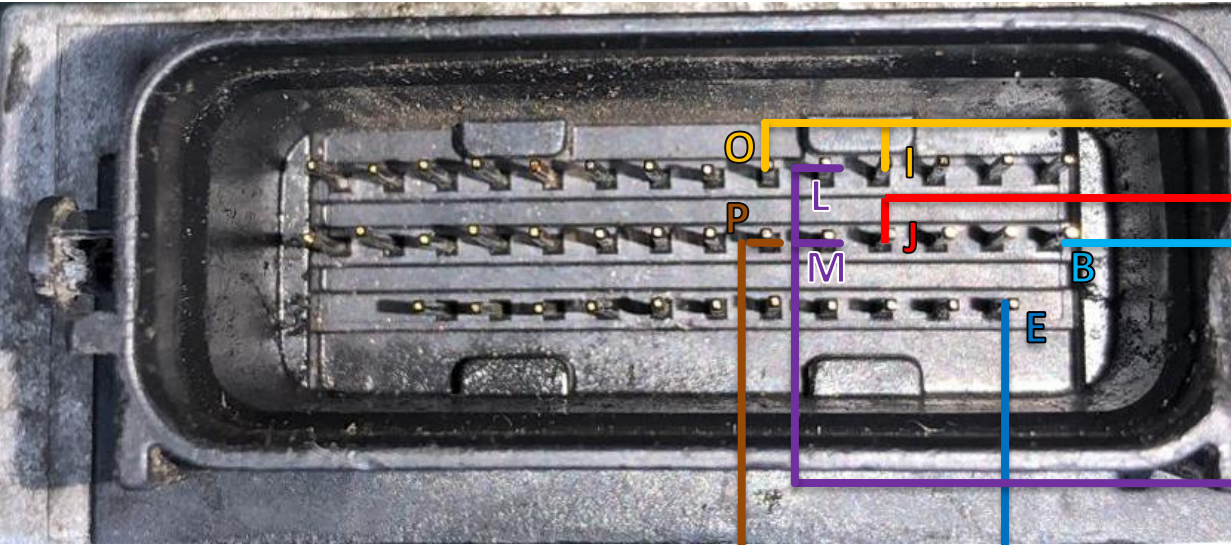

[Regresar al menú](#)

www.scanator.com.mx/alimentadora

Ecu Ford Fiesta 2012
EMS 2205

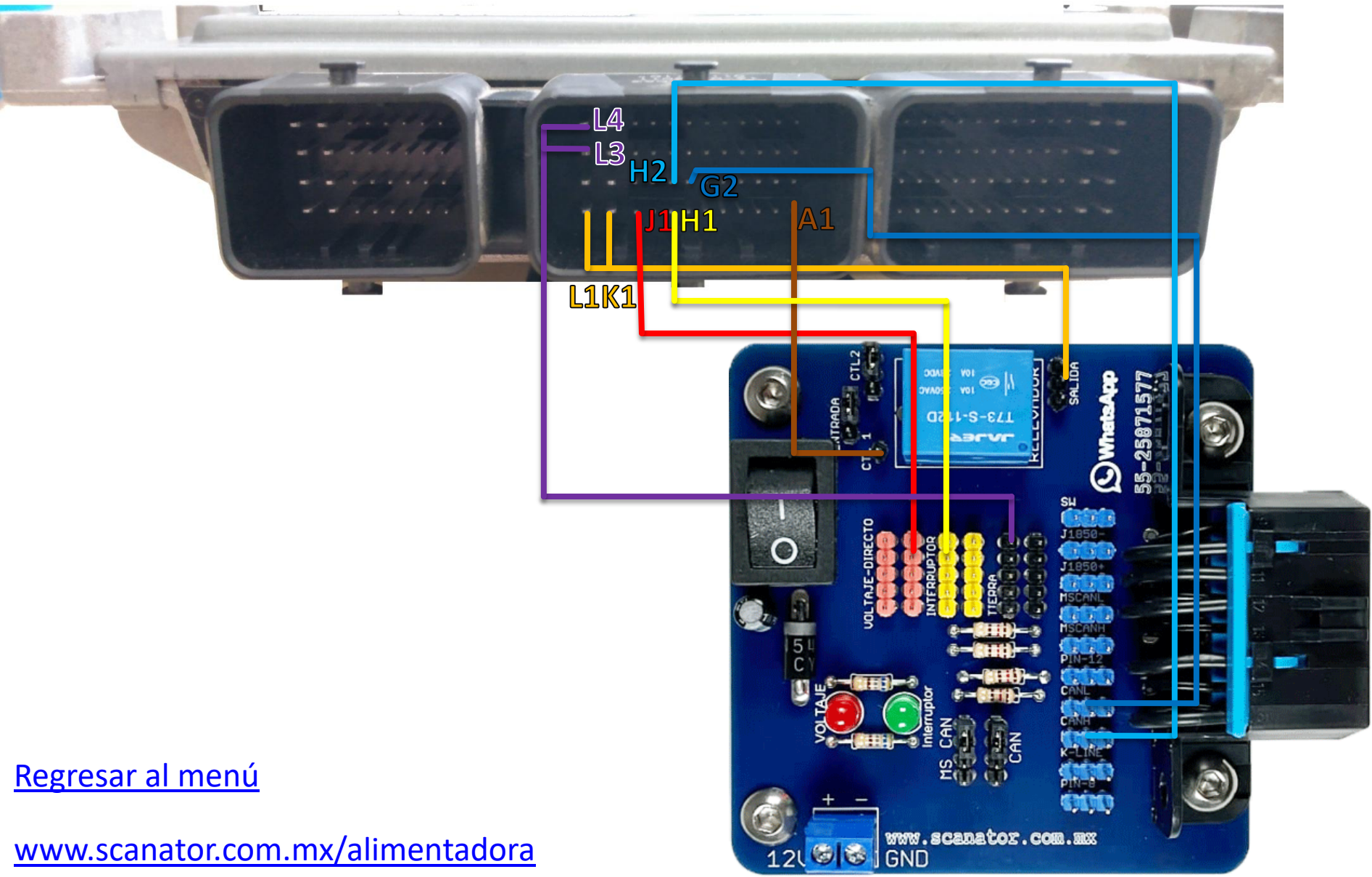

[Regresar al menú](#)

www.scanator.com.mx/alimentadora

ECU Ford Ranger 1999 y 2000

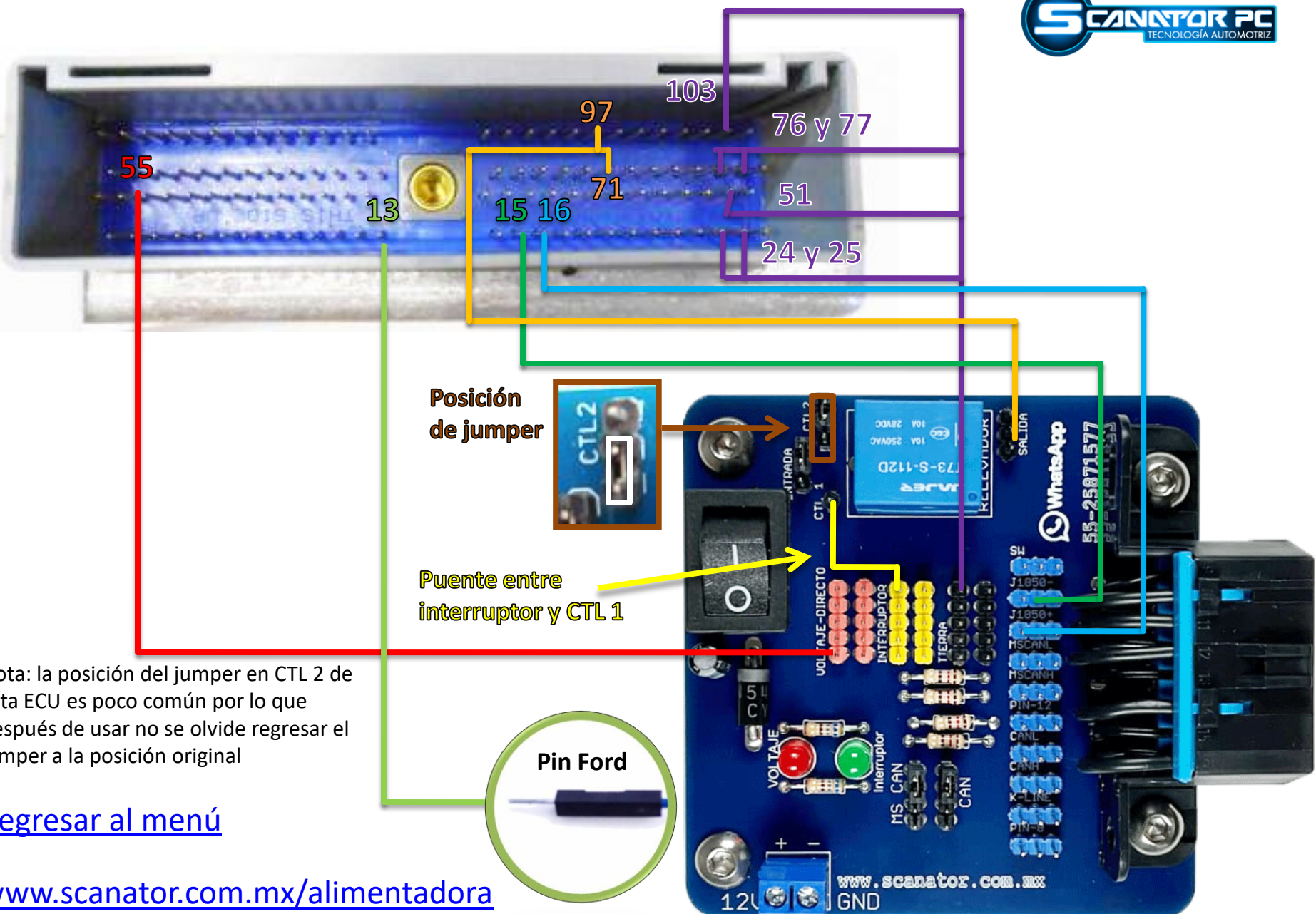

Nota: la posición del jumper en CTL 2 de esta ECU es poco común por lo que después de usar no se olvide regresar el jumper a la posición original

[Regresar al menú](#)

www.scanator.com.mx/alimentadora

ECU Chevy OBD1

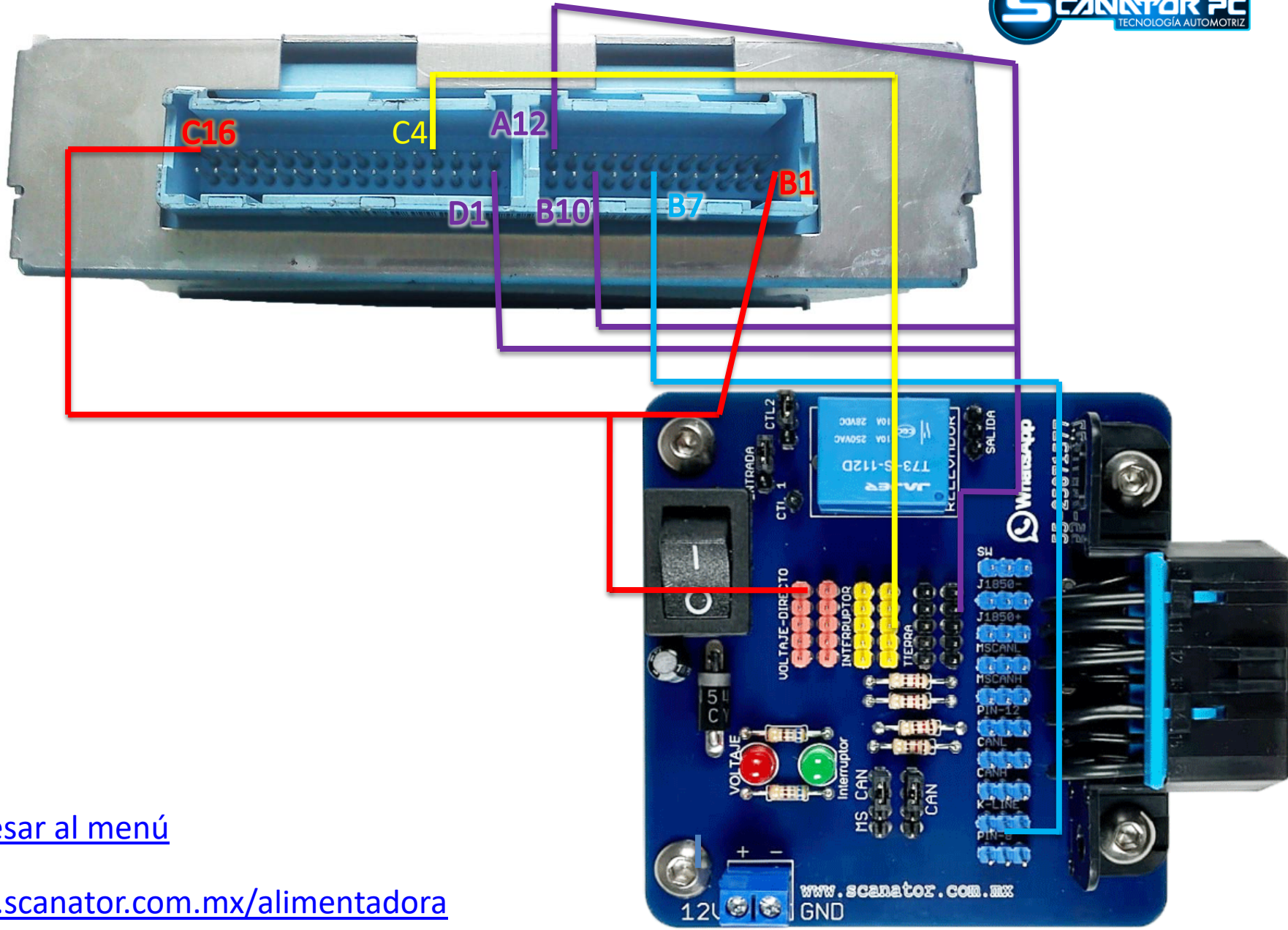

[Regresar al menú](#)

www.scanator.com.mx/alimentadora

Ecu Caravan 1996 80 pines

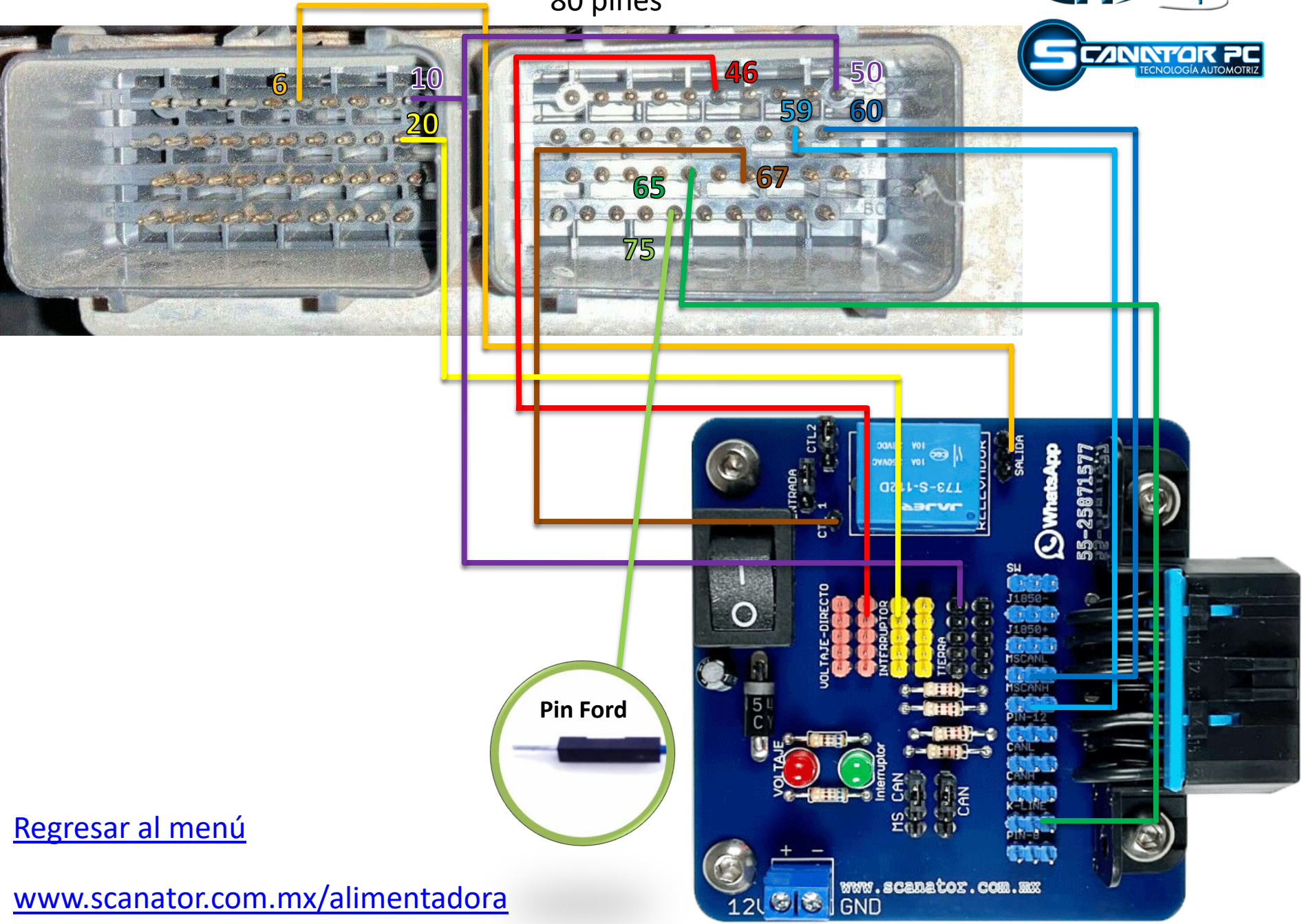

[Regresar al menú](#)

www.scanator.com.mx/alimentadora

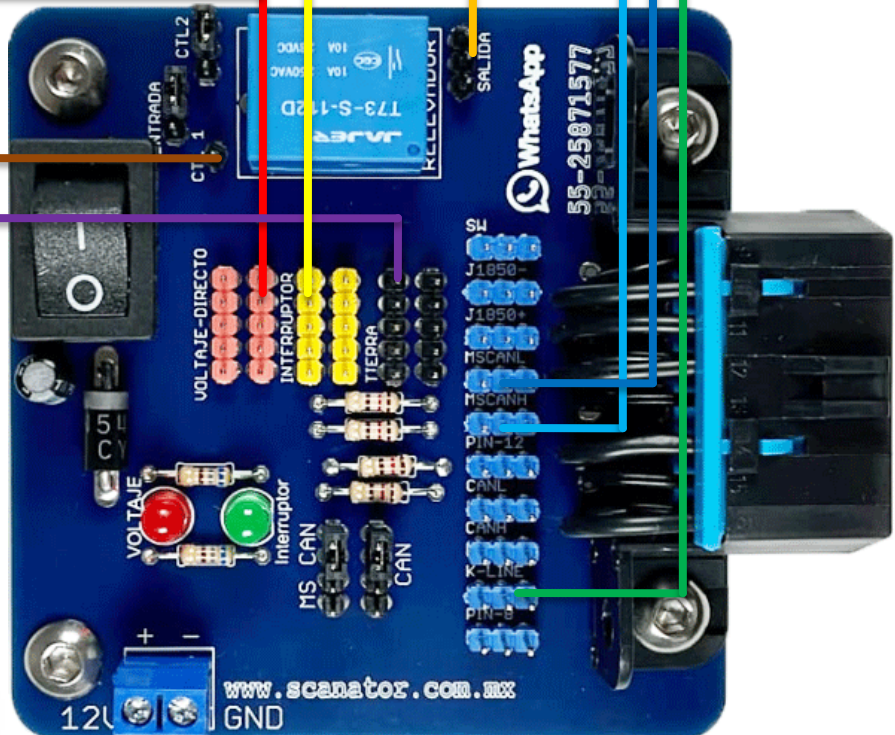

Conexión Jeep Commander 4WD V8 4.7 2006

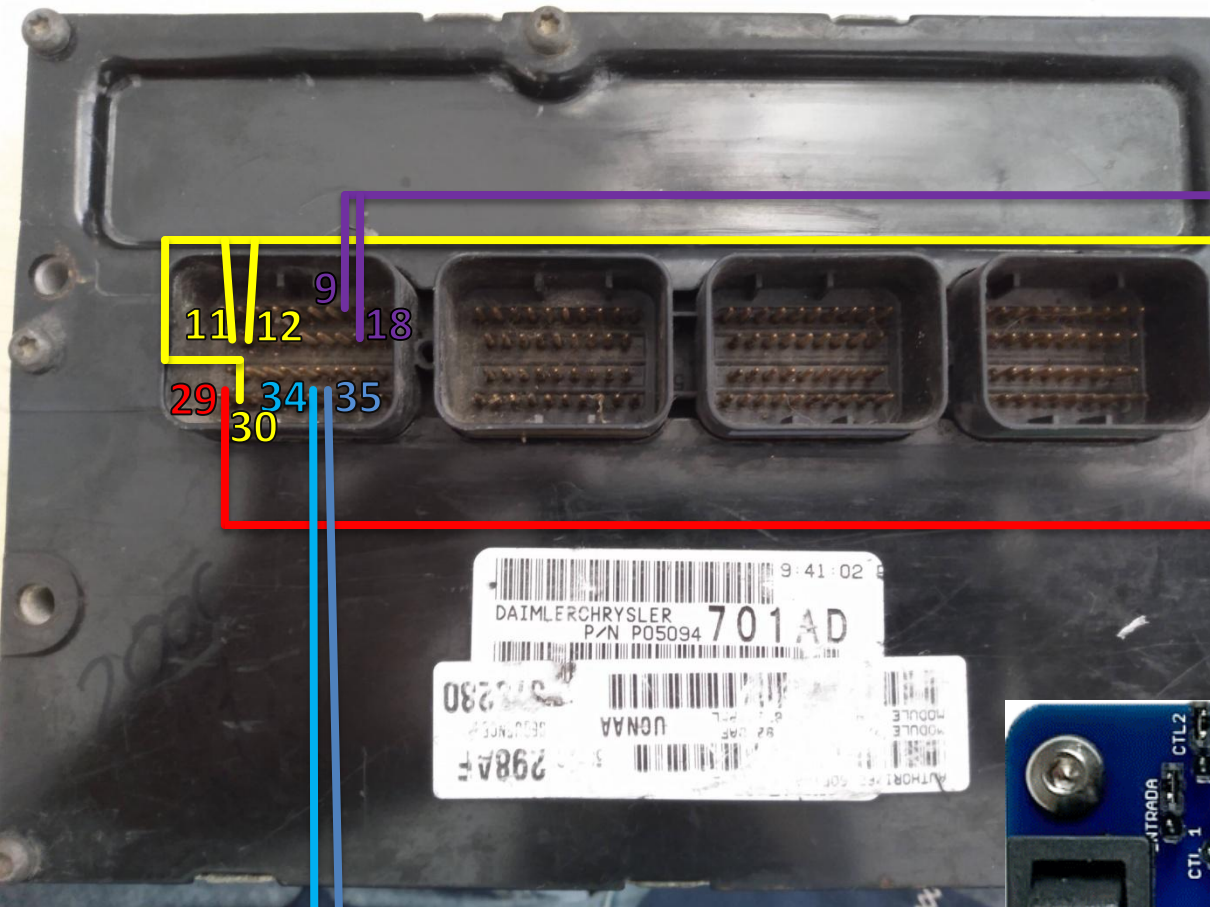

9 41 02
DAIMLERCHRYSLER
P/N P05094 701AD
298AF
UONAA
372280

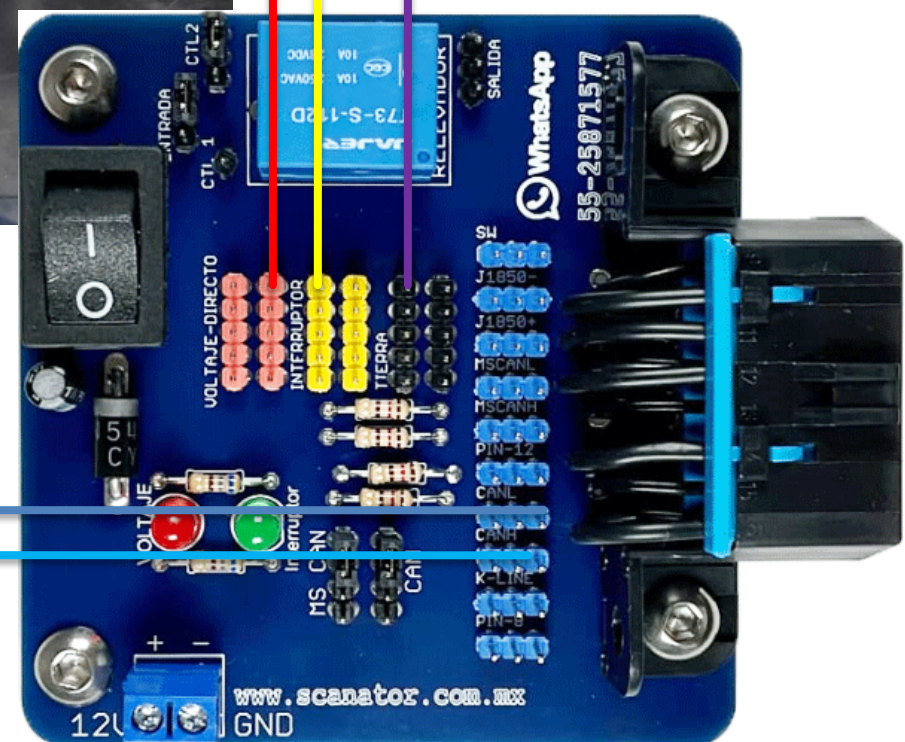

[Regresar al menú](#)

www.scanator.com.mx/alimentadora